

# **TECHNO MAN**

**PACKAGING SOLUTIONS LLC**

**FOOD PRODUCTS  
FILLING & PACKAGING EQUIPMENTS**



+971 56 402 3022 / +971 58 597 1022  
sales@technomps.com / sales1@technomps.com  
www.technomps.com



New Ind. Area 1,  
Ajman -U.A.E

## AUTOMATIC STICK PACKING MACHINE



Model: TMPS-SP388  
 Bag size: W50-150mm, L: 50-200mm  
 Max film width: 300mm.  
 Packing speed: max 60 bags/min  
 Metering range: 50-500ml  
 Power supply: 220 V, 2 KW  
 Air required: 0.6Mpa  
 Machine size: L1500xW680 xH1950mm.

## AUTOMATIC LIQUID SACHET PACKING MACHINE



Model: TMPS-240L  
 Film Width: Max. 240mm  
 Bas Length: 40-120mm  
 Bag Width: 40-120mm  
 Film Roll Diameter: Max. 300mm  
 Filing range: 50-200ml  
 Packaging Rate: 10-80bag/Min  
 Power: 220V 50/60Hz 800W  
 Air required: 0.6Mpa

## AUTOMATIC CUP FILLING AND SEALING MACHINE



Model: TMPS-CFS1000  
 Filling capacity: 10-300m  
 Packing speed: 1000Cup/hour  
 Voltage: 220V 1Phase  
 Power: 1KW  
 Air required: 0.6Mpa  
 Machine dimension: 100x100x175cm  
 weight: 300Kg

## ALL IN ONE MULTIHEAD PACKING MACHINE



Model: TMPS320W / TMPS420W / TMPS520W  
 Filing Volume: 5sm-300sms/1000sms/2000gms  
 Bas size [WxL]: 150x200mm/220x300/250x350mm  
 Max film width: 320mm/420mm/520mm  
 Packing speed: Max 60 bags/min  
 Power supply: 220 V 2 KW, 50 Hz  
 Air required: 0.6Mpa

## AUTOMATIC SERVO AUGER FILLING MACHINE



Model: TMPS-PM250  
 Packing Range: 5gm to 50gm  
 Filling System: Servo Auger Filler  
 Type of Sealing: Center Seal  
 Max film width: 250mm width  
 Film Roll Size: 00-280mm max.ID-7bmm  
 Speed: 40 to 60bags/min.  
 Power supply: 380V 3Phase  
 Air required: 0.6Mpa

## FTM-B320 PACKING MACHINE (SINGLE BELTS)



Model: TMPS-B320  
 Bas size: W50-150mm, 180-200mm  
 Max film width: 320mm.  
 Packing speed: max 60 bags/min  
 Power supply: 220V, 2 KW, 50 Hz  
 Air required: 0.6Mpa  
 Machine size: L1115 xW800 xH1370 mm  
 Weight: 300 kg

## FTM-B420 PACKING MACHINE (DOUBLE BELTS)



Model: TMPS-B420  
 Bag size: W90-200mm, L60-300mm  
 Max film width: 420mm.  
 Packing speed: MAX 60 bags/min  
 Pulling belt type: double belt  
 Power supply: 220 V, 2.2 KW, 50 Hz  
 Air required: 0.6Mpa  
 Machine size: L1530xW970xH1600 mm

## FTM-B520 PACKING MACHINE (DOUBLE BELTS)



Model: TMPS-B520  
 Bas size: W100-250mm, L80-350mm.  
 Max film width: 520mm.  
 Packing speed: Max 50 bags/min  
 Power supply: 220 V 2.5 KW, 50 Hz  
 Air required: 0.6Mpa  
 Machine size: L1430xW1200 xH1700 mm  
 VWeight: 680 kg

## FTM-B720 / FTM-B1000 PACKING MACHINE



Model: TMPS-B720 / TMPS-B1000  
 Bag size [WxL]: Upto350x450mm / Upto500x800mm.  
 Max film width: 730mm/1050mm  
 Packing speed: Max 40 bags/min / Max 20 bags/min  
 Power supply: 220 V, 4.5KW, 50 Hz  
 Air required: 0.6Mpa  
 Machine size: L1680xW1480 xH1900 mm  
 Weisht: 900 kg

## FTM-520T PACKING MACHINE (FOUR EDGES SEALING, FLAT BOTTOM BAGS)



Model: TMPS-520T  
 Bag size:  
 Front Width70-180mm xSide Width: 40-100mm  
 Width of side seal: 5-10mm,  
 Bas Height:100-350 mm,  
 Max film width: 520mm.  
 Packing speed: Max 50 bags/min.  
 Power supply: 220 V, 3.5 KW, 50 Hz  
 Air required: 0.6Mpa  
 Machine size: L1700xW1420 xH1850mm

## FTM-720T PACKING MACHINE (FOUR EDGES SEALING, FLAT BOTTOM BAGS)



Model: TMPS-720T  
 Bag size:  
 Front Width100-290mm x Side Width: 50-120mm,  
 Width of side seal: 5-10mm  
 Bag Heisht:100-420 mm,  
 Max film width: 700mm.  
 Packing speed: Max 40 bags/min.  
 Power supply: 220 V, 3.5 KW, 50 Hz  
 Air required: 0.6Mpa  
 Machine size: L1700xW1650 xH2000mm

## SEMI AUTOMATIC AUGER FILLING MACHINE WITH RIBBON BLENDER & SCREW CONVEYOR



ModelNO:FTM-A1000  
 Fillins Weight: 100g-1000g  
 Accuracy: +1%  
 Measurement Method: Screw  
 Filing Speed: 0-50 fls/min  
 Contact Materials: SUS 304  
 Filling Motor: Stepper Motor/ Servo Motor  
 Hopper Volume: 50 Liters  
 Ribbon Blender:100Ltr/200ltr/500Ltr/1000Ltr

## AUTOMATIC ROTARY PICK FILL SEAL MACHINE



Model: TMPS-RP8-200B/TMPS-RP8-260B/TMPS-RP8-300B  
 Metering Range: 5s-1500g/10g-2000g/20g-2500g  
 Speed: 10-50 bags/min/10-45 bags/min /10-40 bags/min  
 Bas Width: 100-210mm/150-260mm/200-300mm  
 Bas Length: 100-350mm/150-400mm/200-450mm  
 Power: 15kw/18kw/20KW  
 Number of Working Position: 8  
 Voltage: 380V 3Phase 50Hz  
 Air required: 0.6Mpa

Measurement: Auger Dosing, Multiheads Weigher, Weish Filer, Liquid Filler or volumetric Cuos Filler

## AUTOMATIC SERVO EDIBLE OIL FILLING MACHINE



Model NO.: TMPS-SFM06, TMPS-SFM08, TMPS-SFM12  
 No. of Nozzles: 6 Nozzles, 8 Nozzles, and 12 Nozzles  
 Fillins range: 100ml to 10.000ml.  
 Flow Meter, PLC & Touch Screen Control  
 Drip tray protects bottles from nozzle product dripping  
 Capacity: 20 to 80 BPM. [Depends on model]  
 Power: 3phase 380V  
 Air required: 0.6Mpa

## TMPS-F250 / TMPS-F250X FLOW PACK MACHINE



Mode: TMPS-F250/TMPS-F250X  
 Packing Speed: Max 140pcs/min  
 Film width: 60-250mm  
 Bas length: 65-190mm or 120-280mm  
 Bas width: 30-110mm  
 Product height: Max 40mm  
 Power supply: 220V1Phase 50Hz  
 Dimension: L3770xW640 xH1350mm

## TMPS-F350 FLOW PACK MACHINE



Model: TMPS-F350  
 Packing Speed: Max 80pcs/min  
 Film width: 60-350mm  
 Bas length: 65-190mm or 120-280mm  
 Bas width: 50-160mm  
 Product height: Max 40mm  
 Power supply: 220V 1Phase 50Hz  
 Dimension: L4020xW770 xH1450mm

## TMPS-F600 FLOW PACK MACHINE



Model: TMPS-F600  
 Packing Speed: Max 60pcs/min  
 Film width: Max 600mm  
 Bas length: 120-450mm  
 Bas width: 50-200mm  
 Product height: 10-80mm  
 Power supply: 220V1Phase 50Hz  
 Dimension: L4380xW970\*H1500mm

## AUTOMATIC MULTIHEADS VFFS PACKING LINE



## AUTOMATIC AUGER FILLER VFFS PACKING LINE



### 10 HEADS WEIGHER



### 14 HEADS WEIGHER



### 14 HEADS WEIGHER (5L HOPPER)



### WORKING PLATFORM



### VOLUMETRIC CUPS FILLER



### AUGER FILLER



### 2 HEADS LINEAR WEIGHER



### 4 HEADS LINEAR WEIGHER



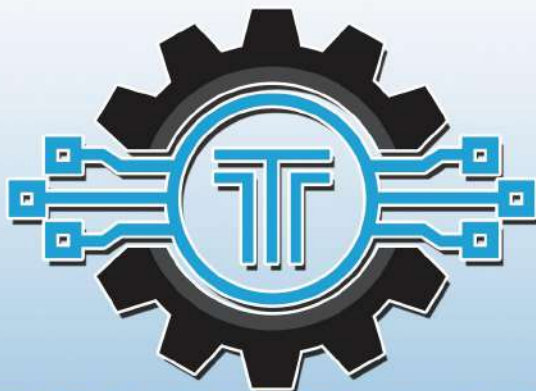

# TECHNO MAN

## PACKAGING SOLUTIONS LLC

[www.technomps.com](http://www.technomps.com)



Providing 24a  
fast  
assistance



Engineers with  
flexible  
service capabilities



Service team  
within  
the organization



Customized  
Modification,  
AMC & Automation



Having a Large  
Supply  
of spare parts

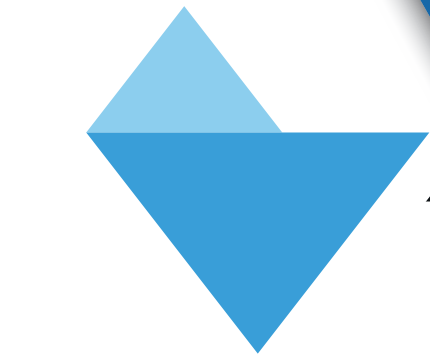
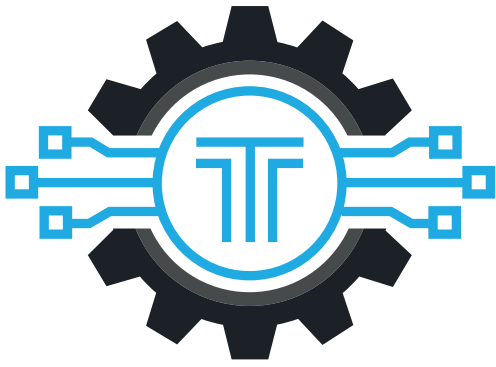

# TECHNO MAN

PACKAGING SOLUTIONS LLC

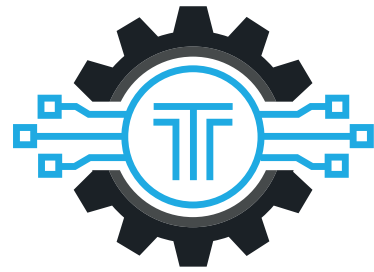
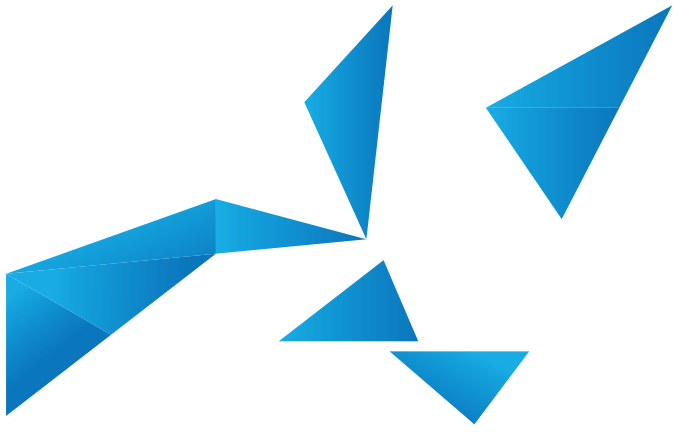

**TECHNO MAN**  
PACKAGING SOLUTIONS LLC

## Industries We Serve



Oil & Lubricant



Pharmaceutical



Detergent

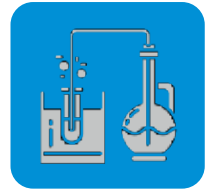

Chemicals



Cosmetics  
&  
Perfume



Food  
&  
Beverage

**PACKAGING**  
◆◆ **SOLUTION**

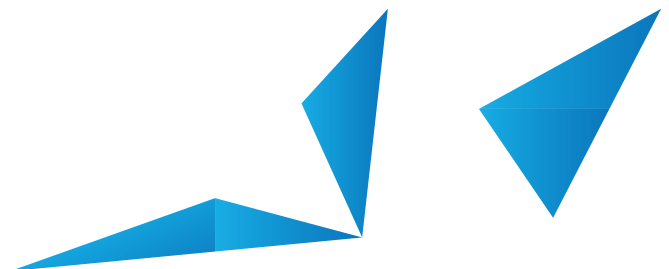



# About Us

**A** leading manufacturer and supplier of packaging machinery for a wide range of industries, including Lubricants, Cosmetics Detergent, Perfume, and Chemicals.

Technoman Machines are known for their simplified engineering, hard build, and long term reliability. Our customers prefer us for our extreme efficiency, production automation, material savings during packaging, and low wastage levels.

**W**e strive to offer cost effective solutions beyond standardization to stand out from the market. We provide personalized solutions to meet special needs of each client. Bottles, caps, and labeling are always evolving and people are always seeking out the latest and innovative ideas. Modern business must embrace change and provide innovative technologies that meet all the market's needs.



## Our Passion

**O**ur team of professionally qualified engineers would love to ignite your business with you. Together, we can provide you with high quality, innovative, easy to operate, and customized packaging machinery solutions in UAE.

**W**e will keep your total cost of ownership to a minimum, and we will not stop until you are completely satisfied. Our commitment to you at Technoman will be as high as our commitment to ourselves.

# Filling Machine

We manufacture liquid filling machines that are capable of handling a variety of liquids, bottle sizes, and production capacities.

We provide liquid filling machines to organizations of all sizes, including small businesses and multinational companies.

Various types of liquid filling machines are available from Technoman Packaging Solutions, Arranging from Manual Single Head Fillers to Fully Automated Multi Head Fillers using Servo Level Filling , Flow Meters and Volumetric Filling.



# Drum & Pail Filling Machine

## Various Filling Technology

- Piston Fillers
- Servo Motor with Gear Pump
- Mass Flow Meter
- Weight Fillers
- Gravity Fillers
- Vacuum Fillers

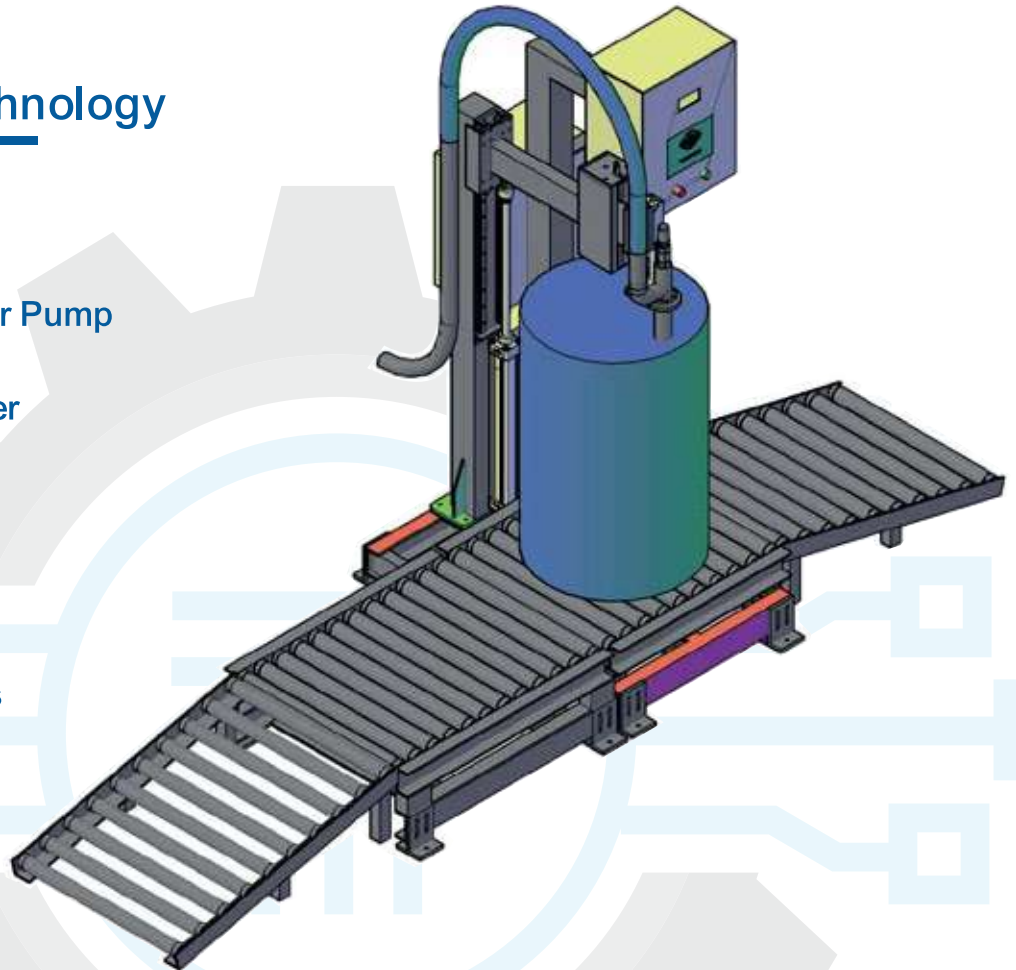

# Label Applicators

We manufacture and supply self adhesive automatic labeling equipment Including both standard and special purpose equipment With our extensive experience with automatic labeling machines, we are able to provide top labels top and bottom labels wrap around labels horizontal wrap around automatic labelers front back automatic labelers as well as corner wraps and tamper proof automatic labels

Our superior consulting, implementation and service capabilities add value throughout the process.



# Capping Machine

We provide Automatic Capping Machines for integration into existing automated capping lines. We offer Semi Automatic Cap Sealing, Automatic Single Head Vial PP or Flip Off Capping tools, Bottle Screw Capping, and Automatic Four Head Bottle Capping equipment. We offer capping machines with 1 to 12 heads.

A wide range of bottle types can be capped using our capping machines. Our product offerings range from screw caps to plastic screw caps and crown caps.



# Induction Machine

## Product:

For pesticide, tablet & capsule  
foods, cosmetic, lubricant & oil packaging etc.  
Plastic bottle and glass bottle sealing.



● Automatic Induction Machine



● Manual Induction Machine



# Strapping Machine



# Carton Sealing Machine



# Multi Head Weigher VFFS Machine

---

Automatic VFFS Vertical form fill seal machine combines with combination like 10 Heads, 14 heads & 2/4 Head Linear Weigher to form the weighing and packaging system.



# Flow Wrapping Machine

---



Servo motor, servo controller, rotary encoder, PLC, touch screen, frequency converter, temperature control module, digital to analog conversion module and other core components are selected brand parts to achieve accurate temperature control, easy speed regulation and high precision With two way tracking, positioning and parking functions, anti aircraft bag design, can minimize the waste of packaging materials Industry catered Biscuits, Chocolates, Vegetables, Fruits etc

# Packaging Machinery



● Automatic L Sealer & Tunnel



● Auger Filler



● Pedal Sealer



● Band Sealer



● Impulse Sealer



● Semi Auto L Sealer & Tunnel

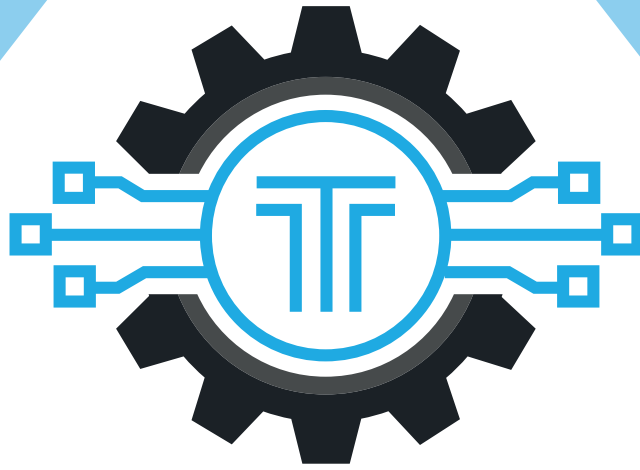

# TECHNO MAN

PACKAGING SOLUTIONS LLC

[www.technomps.com](http://www.technomps.com)



Providing 24/7  
fast assistance



Service team within  
the organization



Engineers with flexible  
service capabilities



Having a Large  
Supply of spare parts



Customized Modification, AMC  
and Automation

## Contact:

+971 56 402 3022

+971 58 597 1022

E-mail:

[sales@technomps.com](mailto:sales@technomps.com)

[sales1@technomps.com](mailto:sales1@technomps.com)

Address:

New Ind. Area 1, Ajman - U.A.E

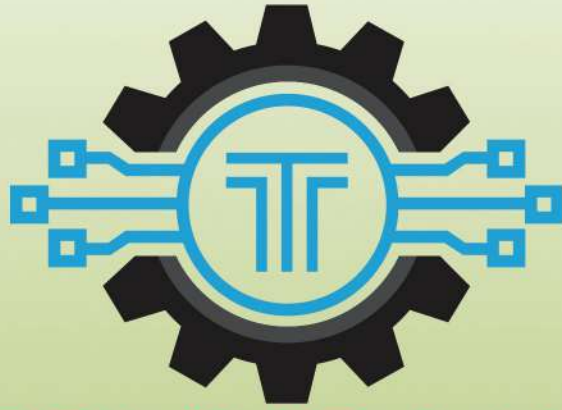

**TECHNO MAN**  
PACKAGING SOLUTIONS LLC

# **PERFUME & COSMETICS PACKAGING MACHINERIES**



+971 56 402 3022 / +971 58 597 1022  
sales@technomps.com / sales1@technomps.com  
www.technomps.com



TechnoMan Packaging Solutions LLC Sharjah  
Media City, Sharjah, U.A.E.P.O: 515000

TechnoMan Machinery Packaging LLC IbrahimHaji  
0184 Building -PlotNo 1196 -No 1, New Industrial Area,  
Ajman, U.A.E.

**Rotary Perfume Filling & Capping Machine**

TMPS-SG-D is an automatic rotary Perfume Cleaning, Filling, Crimping, and collaring machine . This is used for filling perfume, floral water, and other water-based materials. It is a rotary type machine with 4 filling heads, which could fill 4 bottles at the same time. It is efficient and labor-saving. It consists of automatic air cleaning, filling, pump positioning, crimping & collaring device. Main function of this machine is automatic by the system. Only need to put bottles, pump & collar manually.



Product Code	TMPS-SG-D
Bottle height	50-180mm
Filling speed	25-35bpm
Filling range	10-150ml
Working station	20
Size	2008mm x 2100mm x1800m
	With adjusting molds
	With explosion proof glass shield

**Features**

- » Mold is adjustable for different sizes/shapes of bottles, but if some shape or size is not normal, then can not use this machine, so general, if customer place order, we should check samples before production.
- » Speed is 25-35 bpm.
- » With automatic pump & collar feeders, this machine only needs one worker to put bottle on mold.
- » With air cleaning system, no need buy extra cleaning machine.
- » Explosion proof electric box and motors.
- » With a small SS304 50L movable storage tank which can control perfume feeding, because it has float ball in side.
- » Machine is small, no need big space.



**Perfume Freezing Filter**

Harnessing advanced freezing technology, this machine promises impeccable separation of impurities, ensuring the pristine quality of every perfume batch.

**Features**

- » This machine is specialized in freezing, clean up, filter cosmetic liquid, perfume.
- » Advantage of this machine are compact structure, space saving, stability, easy to operate.
- » This machine is made by SUS304 material, adopt USA Sandpiper pneumatic transfer pump to transfer liquid and give pressure.
- » Adopt imported France Maneurop freezing device. Cooling by Titanium alloy coil.
- » Circulation and cooling system adopts sanitary SUS304 material pipes.
- » Easy to operate, install, disassemble and clean.
- » SS temperature preservation cooling tank and Titanium metal coil.
- » Freezing device(origin: France).
- » Anti-corrosive pneumatic transfer pump(origin: USA).
- » Polypropylene Microporous Filtration Membrane.
- » SS movable stand.
- » Sealed electronic control system and sanitary pipe valves.



**Storage Tanks**

It is a customized series. The working capacity, material etc. can be made according to the customer's requirement. It is an ideal storing equipment for daily cosmetic pharmaceutical, food industry that meet the GMP standard.



**Moveable Sealed Tank**



**Tank with Double Layers**



**Tank with Pneumatic Mixer**



**Horizontal Storage Tank**

**Bottle Washer**

Elevate your cleaning operations with TECHNO MAN Bottle Washer, the epitome of efficiency and precision. Boasting an impressive 48 washing heads, this machine effortlessly handles a robust cleaning capacity of 2,000 to 3,000 bottles per hour. Engineered with an energy-efficient 1.25Kw/220V motor featuring frequency control, it ensures optimal performance while minimizing operational costs.



Product Code	TMPS-SXP-B
Washing Heads(pcs)	48
Capacity(B/H)	2000 - 3000
Motor Power	1.25Kw/220V/Frequency Control
Suitable Bottle Height (mm)	50 - 150
Suitable Bottle Diameter (mm)	25 - 80
Water Consumption	1.5m <sup>3</sup> /h
Working Pressure (Mpa)	0.2 - 0.4
Machine Weight (Kg)	330

**Air Cleaning Machine**

Experience unmatched purity and efficiency with TECHNO MAN state-of-the-art Air Cleaning Machine. Engineered for optimal performance, this machine boasts a swift cleaning speed, handling 30-40 bottles per minute, ensuring every container meets the highest hygiene standards. With a precise air consumption rate of 60 L/min and operating under a consistent air pressure of 4-5 kgf/cm<sup>2</sup>, this machine is synonymous with reliability and efficiency.



Product Code	TMPS-QSP
Washing Speed(B/min)	30-40
Air Consumption(L/min)	60
Air Pressure (kgf/cm <sup>2</sup> )	4-5
Power Supply(V/Kw)	220 / 0.4
Machine Weight (Kg)	78
Machine Dimensions (LxWxH)mm	700 x 610 x 1230

**Features**

- » Easy and convenient operation.
- » It can clean the dust and impurity inside the bottle, with device to eliminate static.
- » The time for cleaning can be set according to your requirement.
- » Adopt double (blow/inhale) working station, clean the dust in the bottle.
- » Ensure the purity of the air source with precise Filter.

**10 Head Rotary Perfume Filling Machine**

It is the ideal automatic perfume filling machine for liquid such as floral water, perfume, lotion, and other materials. Continuous rotary filling, suitable for all kinds of bottles without changing the mold can provide explosion proof type.



Product Code	TMPS-SG-C
Filling Scope (ml)	30-500
Production Capacity (B/H)	1000-3000
Rotary Control	Frequency stepless
Vacuum Control	Imported Pneumatic Vacuum Generators
Single Machine Noise	≤70dB
Machine Dimensions (mm)	1168 x 1168 x 2000
Machine Weight (Kg)	900

**Semi Automatic Four Head Filling Machine**

Experience precision and efficiency with TECHNO MAN Semi Automatic 4 Head Filling Machine. Designed for optimal throughput, this machine boasts a filling speed of 40 bottles per minute, ensuring swift operations without compromising on accuracy. Equipped with four dedicated filling heads, it offers consistent and uniform filling, adaptable to a wide range of volumes up to 500ml.



Product Code	TMPS-SG-C
Filling speed	40 bottles/min
Filling Volume (ml)	0-500ml
Filling heads	4
Bottle Height (mm)	≤250mm
Max diameter (bottle hole)	≤20mm
Suction speed	5.5L/min
Power	220V/50Hz

**Semi Auto Pump Pipe Cutting Machine, Collaring Machine & Crimping Machine**

The Pump Pipe Cutting machine is capable of handling a wide variety of pump pipe sizes. It has a cutting range of 30 - 140mm.

The Perfume Collaring Machine precision mechanism guarantees that each collar is placed accurately, enhancing the visual appeal and ensuring the integrity of the perfume bottle's design.

Perfume Crimping Machine operates through a clamping mechanism, that meticulously closes the cap, anchoring it firmly to the bottle's edge.



Pump Pipe Cutting Machine



Collaring Machine



Crimping Machine



**Belt Conveyor**



Product Code	TMPS-BP
Material	Stainless Steel SUS304; Thickness:1,2mm; supporter:38x38
Rack	with leg supporter, the range of the height is 0-10
Belt (mm)	imported from holland, width:250, match with the platform
Platform (mm)	Stainless steel, width: 250x2, protector: 30x2
Motor Power (Kw)	0.55
Bearing Weight (Kg)	200
Frequency Converter	Taiwan Taida

**Features**

- » Adopts Frequency control » Simple structure, convenient operation.
- » The whole machine is made from stainless steel.
- » Equipped with belt imported from Holland.



**Aerosol Packaging Machine**

The Automatic Aerosol Filling Machine, crafted with advanced technology, offers a refined and efficient solution for aerosol packaging needs. Its independent control over the filling end ensures that there is no discharge without filling, promoting cost-effectiveness and reducing wastage.

Moreover, the machine is designed with a sealing-guided feature, providing automatic halts in operation if it detects subpar sealing quality. It employs a highly accurate and efficient inflation method at the charging end, which minimizes gas consumption.

For added convenience, the machine can be coupled with an automatic weighing machine to enhance precision in your production line. This comprehensive system comprises an automatic inlet device, three liquid filling nozzles, a capping device, and three gas filling nozzles, ensuring a streamlined and high-performing aerosol packaging process.

The whole machine is controlled by pneumatic and can be controlled separately. No can, no material out.



## Semi Automatic Overwrapping Machine

The Semi Automatic Overwrapping Machine is a highly efficient and adaptable solution designed specifically for wrapping small and medium-sized boxes.



Product Code	TMPS-MINI
Lenght (L)	Min 50 mm - Max 250 mm
Height (H)	Min 30 mm - Max 80 mm
Capacity	5 - 20
Width (W)	Min 50 mm - Max 150 mm
Outline Dimensions	150 x 85 x 110 cm
Power	1 KW, 1 Phase, 220 VAC

## Automatic Overwrapping Machine for Small & Medium Size Boxes

This machine is an ideal choice for industries seeking a reliable and automated solution for overwrapping boxes of various sizes, providing efficiency and flexibility in packaging operations.



Product Code	TMPS2003-SF
Lenght (L)	Min 50 mm - Max 310 mm
Height (H)	Min 10 mm - Max 80 mm
Capacity	20 - 40
Width (W)	Min 50 mm - Max 110 mm
OPP Lenght	Min 150 mm - Max 420 mm
Power	3.5 KW, 380V - AC 3 Phase

## Automatic Overwrapping Machine for Medium, Big & Multi Box Pack

Our Automatic Overwrapping Machine for Medium & Big Size Boxes is an ideal choice for industries dealing with larger box dimensions.

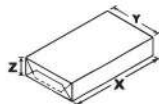

Product Code	TMPS55-SRV
Lenght (L)	Min 50 mm - Max 310 mm
Height (H)	Min 20 mm - Max 100 mm
Capacity	10 - 30
OPP Lenght	Min 150 mm - Max 580 mm
Width (W)	Min 50 mm - Max 210 mm
Power	5 KW, 380V - AC 3 Phase

## Lotion Making Machine / Emulsifier

Our range covers an extensive capacity spectrum from 10L all the way up to 3000L, ensuring we cater to both artisanal creators and large-scale manufacturers. Choose from 10L, 20L, 30L, 50L, 80L, 100L, 200L, 300L, 500L, 1000L, 2000L, and 3000L models based on your production requirements.



Product Code	TMPS
Application	Liquid With Suspended Solids
Type	Fix And Tilting
Control	Button Control Or By Touch Screen
Mixer Type	Homogenizer
Mixing Speed	0-80 R/M
Heating Method	Steam Or Electricity
Material	SUS304 And SS316
Usage	Produce Cream, Gel, Lotion, Shampoo Etc

### Features

- » Strictly made according to GMP standard design and production , polish meet 300U.
- » The inner parts adopts 316 stainless steel.
- » Bearing adopts Japanese NSK.
- » Imported frequency conversion control.
- » Machinery sealing with excellent sealing quality and performance, the homogenizer can work 24 hours continuously.
- » Scraper blending and stable blending work at the same time.
- » Electric heating and steam heating option.
- » Wide suitability
- » Labour saving
- » Easy to use and maintain



## Automatic Tube Filling Sealing Machine

In the dynamic world of packaging, TECHNO MAN brings forward the epitome of technological brilliance – the Automatic Tube Filling Sealing Machine. A perfect amalgamation of speed, precision, and adaptability, it's meticulously crafted to cater to the ever-evolving demands of modern industries.



Operation Speed	30-50/min/max
Filling Range	3-250ml
Suitable Tube Length	50-210mm
Suitable Tube Diameter	12-50mm
Working Pressure	0.5-0.6MPa



**Automatic Lotion / Cream Filling & Capping Machine**

Elevate your production line with the Automatic Lotion/Cream Filling & Capping Machine by TECHNO MAN – a synergy of efficiency, precision, and cutting-edge technology tailored for the skincare industry.



Product Code	TMPS-SRG-A
Production Capacity	10-20 bottles/min (according to operation staff and filling range)
Cleaning	Electrostatic eliminating air, vacuum suction
Nozzle Lifting Control	Panasonic Servo Motor Control
Filling System	Panasonic Servo Motor Control
Capping System	Panasonic Servo Motor Control
Discharge	Unilateral Clamping Type
Power Supply	220V /2KW Single Phase
Air Pressure Source	0.5Mpa ~ 150L/min

**Automatic Lotion / Cream Filling Machine**

Discover precision engineering combined with relentless efficiency in the Automatic Lotion/Cream Filling Machine by TECHNO MAN – a prime choice for skincare professionals and manufacturers who prioritize excellence.



Product Code	TMPS-ZDGT-A
Suitable Bottle Size	Ø 20 ~ Ø 100mm
Production Capacity	1000~3000 (filling range, container diameter varies)
Power Source	220V/50Hz
Electric Power (Kw)	≤0.5
Required Air pressure (Mpa)	0.4 ~0.8
Speed Control	Frequency Control
Noise of Single Machine	≤70dB
Machine Weight (Kg)	260

**Semi Automatic Lotion / Cream Filling Machine**

Dive into a world of precision, efficiency, and adaptability with TECHNO MAN Semi-Automatic Lotion/Cream Filling Machine. Expertly crafted to suit the nuanced requirements of both cosmetics and pharmaceutical industries, this machine is the nexus of innovation and reliability.



Product Code	TMPS-GT
Filling Scope (gm)	3-30 / 5-150 / 20-500
Production Capacity	20-40(Pcs/min)
Filling Accuracy	0.5%
Filling Quotas	1 pc
Number of Hopper	1
Hopper Capacity	35L
Drive Pressed Air	4kg/cm <sup>2</sup> - 6kg/cm <sup>2</sup>



Thin Liquid



Thick Liquid



**Automatic Straight Line Piston Filling Machine**

Tailored to meet diverse production demands, our filling line offers a choice of nozzle configurations. Whether you opt for 4, 6, 8, 10, or 12 nozzles, you are ensured swift and accurate fills every time, perfectly suited to your operational pace and volume



Filling volume: 100-1000 ml, 200-2000 ml, 500-5000ml

Product Code	TMPS 5600				
Nozzle No	4	6	8	10	12
Capacity (bottle/h)	≤1300	≤1900	≤2600	≤3200	≤4000
Filling Precision	≤±0.5%				
Power Supply	220V / 380W 50-60Hz				
Compressor (Mpa)	0.5 - 0.8 Mpa				
Consumed Power (Kw)	2.5	2.5	2.8	3.5	3.5
Dimension (mm)	1600 X 1260 X 2550	2180 X 1260 X 2550	1600 X 1460 X 2550	1900 X 1460 X 2550	2180 X 1460 X 2550

**Features**

- » The filling range starts from 100-1000ml to 500- 5000ml.
- » Servo based system for filling volume.
- » Using double speed technology to improve production efficiency and prevent material from spilling out.
- » The adjustment of filling volume is convenient, can be set directly on the touch screen.
- » Special diving nozzles for foamy products.
- » No bottle, No filling function as standard.
- » Stable performance & high accuracy.

**Capping Machine**

TECHNO MAN, we specialize in a diverse range of capping solutions tailored to meet various industrial needs. Among our notable products is the "Linear Capping Machine for Plastic Caps" designed for efficient and consistent capping. For those seeking automation, our Capping machines offer precision and speed, ensuring containers are securely sealed with caps with safety and accuracy in the process.



**Automatic Press Capping Machine**

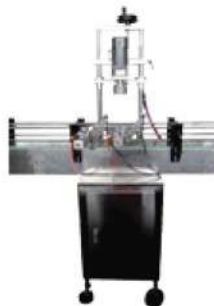

**Single Head Automatic Screw Capping Machine**



**Linear High Speed Capping Machine(Screw Type)**

**Online Induction Cap Sealing Machine**

Utilizing a sophisticated non-contact heating process, this machine perfects the art of hermetically Sealing containers.



Product Code	TMPS-3000	TMPS-2000	TMPS-2000A
Machine Type	Water cooled		Air cooled
Sealing Diameter	20 to 148mm	20 to 60mm	20 to 120mm
Frequency	50-60Hz		
Output Power	3 KW	2 KW	3 KW



**Sleeve Applicator & Shrink Machine**

The Automatic Sleeve Applicator is an all-in-one labeling solution designed to streamline your production process. Widely utilized in the beverage, dairy products, cosmetics, food, alcohol, and pharmaceutical industries, this machine offers an impressive adaptability to various container shapes, including round, square, or flat bottles, yogurt cups, empty bottles, beer bottles, and more.



**Features**

- » High Stability of the mechanical structure.
- » A protective cover and man-machine interface operating system, makes the whole machine more simple to control and use.
- » The machine can be worked with the whole production line or as a stand alone machine.
- » Unique knife plate design, within the scope of our specification, can avoid changing it.
- » Forced sleeve-label style, very economical.
- » Overall rotation system, can be linked to adjustment, suitable for various label rolls'specification.
- » Inner diameter of the label roll: 5"-10", can be adjusted differently.





### Double Side Self Adhesive Labeling Machine

Used for the surface labeling of square, flat & round objects in industries such as food, beverage, pharmaceutical, oil, cosmetics etc.



### Round Bottle Self Adhesive Labeling Machine

Automatic labeling of round bottles in industries such as food, beverage, pharmaceutical, oil, cosmetics etc.



### Sticker Orientation Labeling Machine For Round Bottles

This machine is a precision-oriented labeling solution designed for round bottles requiring specific label positioning.



### Automatic Box Top Surface Labeling Machine

This machine is ideal for industries that require quick and efficient labeling processes. It is engineered to handle great flexibility for a broad range of packaging dimensions.



### Automatic 3 Side Labeling Machine

This machine provides the flexibility of allowing seamless integration into any production line. It impresses with a yield of 30 to 120 pieces per minute depending on bottle and label size, ensuring high-speed labeling without compromising on accuracy.



### Desktop Round Bottle Labeling Machine

High-performance labeling solution designed specifically for round bottles. Its compact desktop size doesn't compromise on speed or efficiency. It is an excellent choice for both small and large-scale operations.

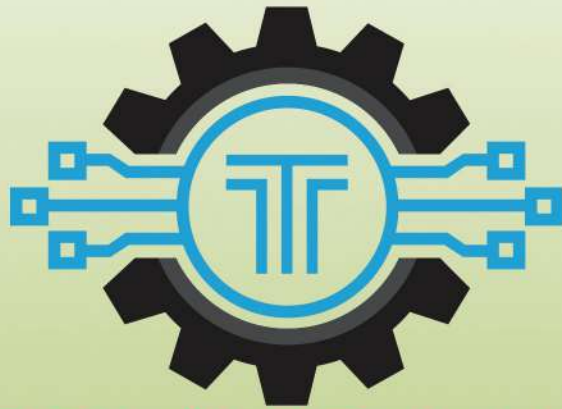

# TECHNO MAN

PACKAGING SOLUTIONS LLC

[WWW.TECHNOMPS.COM](http://WWW.TECHNOMPS.COM)



Providing 24a  
fast  
assistance



Engineers with  
flexible  
service capabilities



Service team  
within  
the organization



Customized  
Modification,  
AMC & Automation



Having a Large  
Supply  
of spare parts