SIRAJCO

Internaional Trading LLC

SIRAJCO INTERNATIONAL TRADING LLC
COMPANY PROFILE

About Us

*Sirajco International Trading established in 2001.
We trade all types of aluminium profiles.*

*Sirajco is one of the approved
materials trader of gulf extrusion profiles in
Dubai region. Sirajco are the suppliers of aluminium
profiles, tubes, angles, flat bars, solid bars etc.*

*Stockiest of aluminium sheets, chequered sheets, stucco
sheets, aluminium composite panels and poly carbonate
sheets.*

*Sirajco is capable of meeting a substantial part of the
requirement for any kind of aluminium profiles
throughout the UAE. Our aluminium profile stock
Includes: Curtain wall profile, 4way structural
glazing profile, Sliding window and doors, Hinged doors
and windows, Partitions and sheets etc.*

*Sirajco International listens to clients and delivers
international quality products and services, they trust
and value, with continued commitment to safety,
also striving to develop mutually rewarding
relationships with its employees
and suppliers, while operating to the highest
ethical and professional standards,
differentiating us from competitors.*

*Our vision is to provide a complete external
architectural building envelope solution and
achieve market leadership through continuous innovation.*



Product Range

Aluminium Profiles :

Aluminium profiles, Curtain Wall, Hinge Doors, Sliding Windows, Hinged Windows, Stair Case , Balcony , sky light , tubes, angles, flat bars, solid bars etc. from Al Ghurair , White Ext, Arabian Ext, National Aluminium, Saudi , Oman , Bahrain etc.

Aluminium Sheets :

Wide Range of Aluminium Sheet from 0.5mm to 30mm

Aluminium chequered Sheets :

Wide Range of Aluminium Chequered sheets from 1mm to 8mm

Stucco Sheets :

Stucco Sheets from 0.65mm to 0.9mm

Poly Carbonates Sheets :

Poly Carbonate sheets obscure , Natural , Colored & Clear sheets & Composite Panels



Aluminium Profiles

10cm Sliding Windows Series

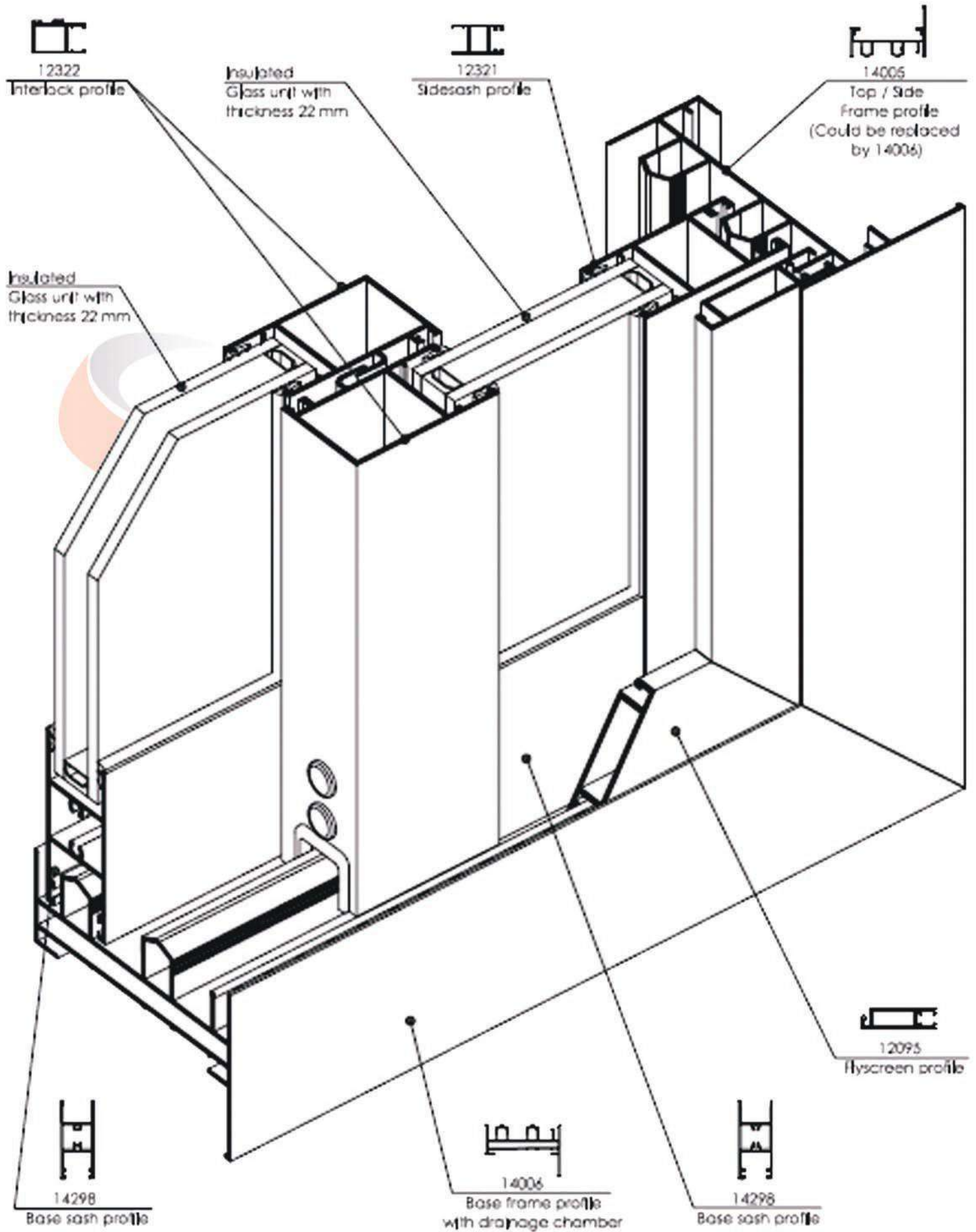

Aluminium Profiles

Sliding Door 125mm

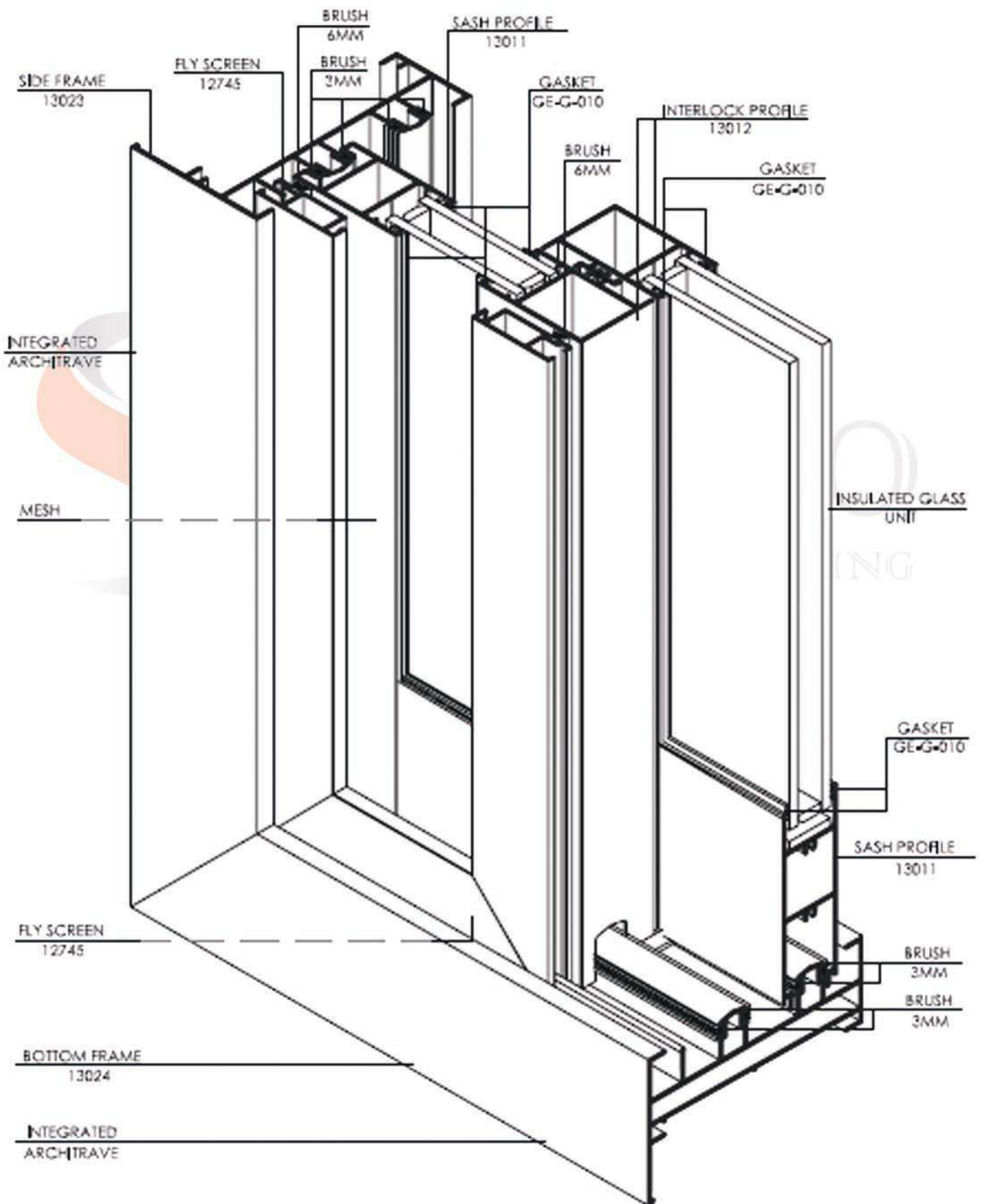

Aluminium Profiles

Hinged 45mm

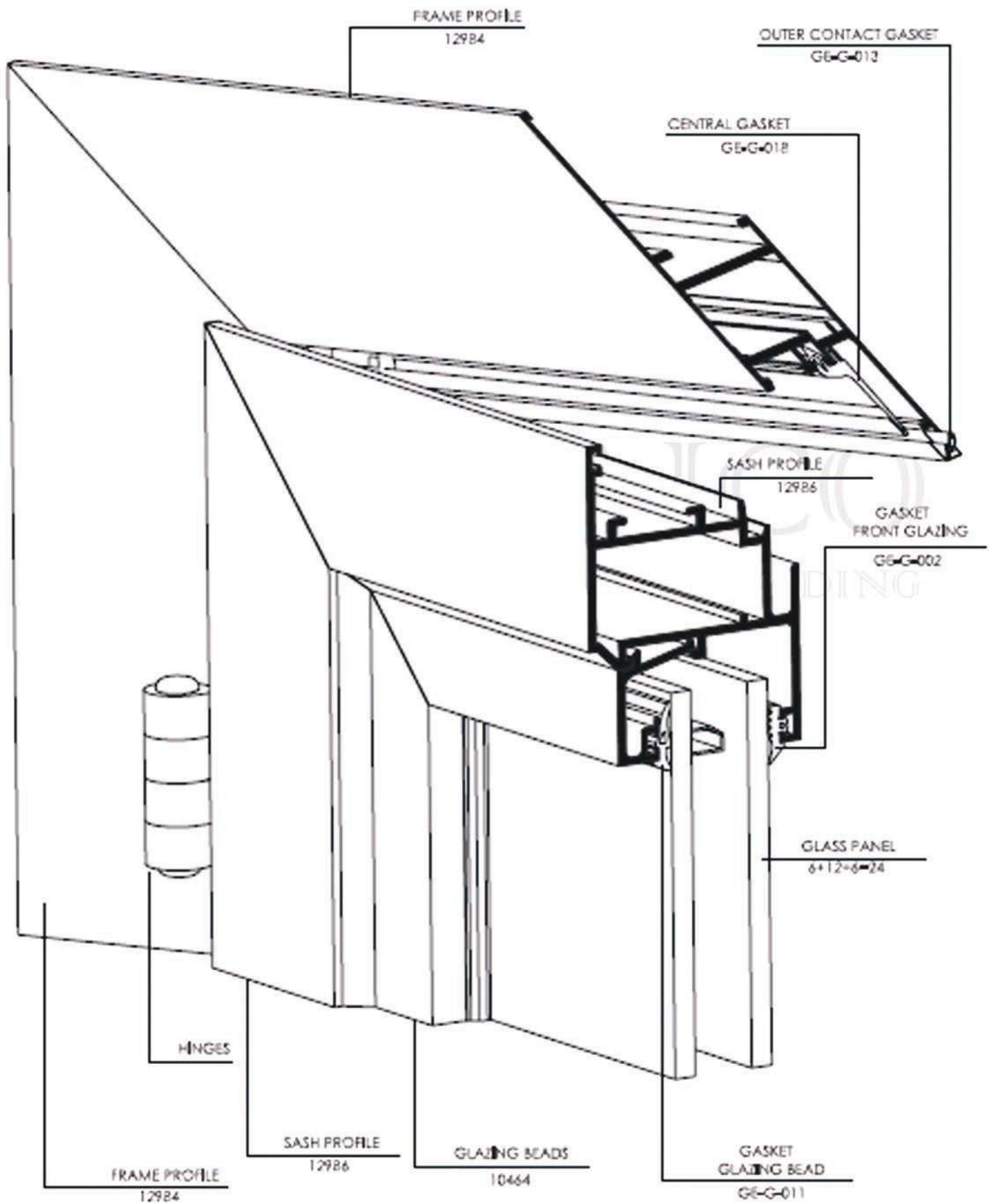

Aluminium Profiles

Hinged 45mm

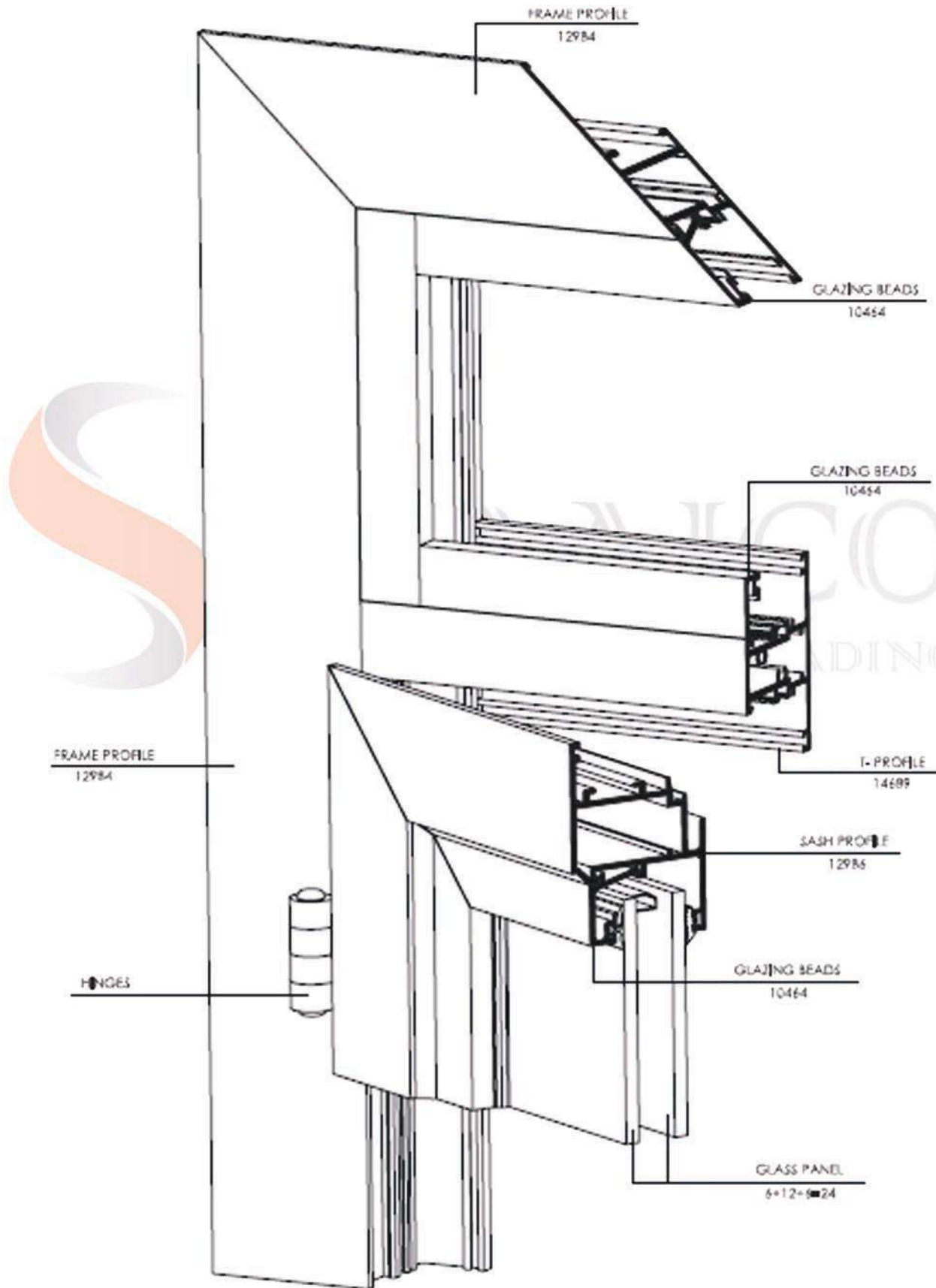

Aluminium Profiles

50mm Curtain Wall

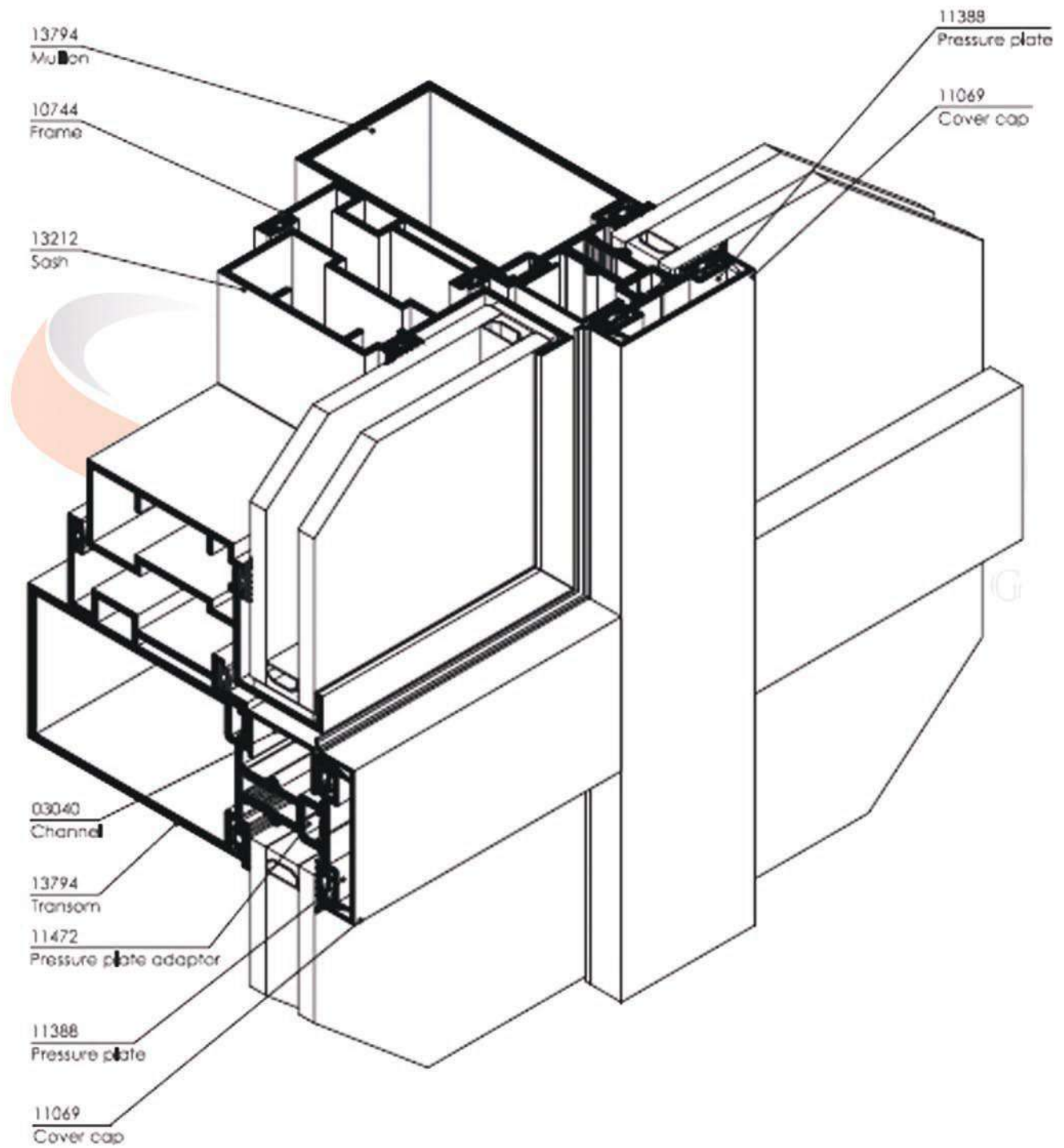

Aluminium Angles

Standard Profiles

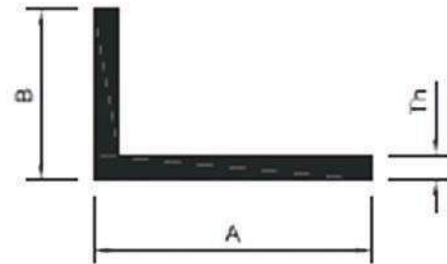
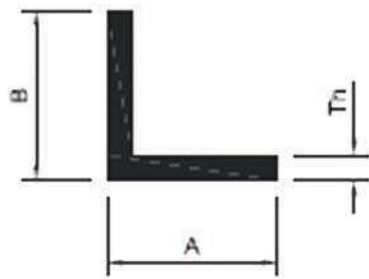

Profile Reference	A mm	B mm	Th mm	Corner Radius	Kg. / m.
01060	8	8	2	--	0.075
01059	13	13	2	--	0.129
01047	15	15	1	--	0.078
01017	15	15	1.3	--	0.101
01012	15	15	1.5	--	0.116
01045	17.5	17.5	1.5	--	0.136
01050	20	20	1	--	0.105
01018	20	20	1.2	--	0.126
01028	20	20	1.3	--	0.136
01013	20	20	1.4	--	0.150
01001	20	20	1.5	--	0.168
01042	20	20	2	--	0.205
01048	25	25	1	--	0.132
01029	25	25	1.2	--	0.158
01014	25	25	1.4	--	0.184
01002	25	25	2	--	0.259
01041*	25	25	3	3	0.376
01054	29	29	2	--	0.302
01049	30	30	1	--	0.159
01036	30	30	1.1	--	0.159
01010	30	30	1.5	--	0.240
01024	30	30	2	--	0.313
01007	30	30	2.5	--	0.384
01019	30	30	2.8	--	0.432
01031	30	30	3	--	0.462
01025	30	30	4	--	0.462
01003	30	30	5	--	0.742
01037	35	35	3	--	0.543

Profile Reference	A mm	B mm	Th mm	Corner Radius	Kg. / m.
02013	20	10	1.5	--	0.115
02036	20	12	6/3.5	--	0.381
02040	22	8	3	--	0.219
02052	30	13	3	--	0.324
02045	30	15	3	--	0.340
02008	30	17	2	--	0.243
02001	30	20	1.5	--	0.196
02034	30	20	2	--	0.259
02009	30	25	4	--	0.551
02016	31	14.7	2	--	0.236
02048*	38	12	1.5	0.75	0.195
02024	38	33	2.8	--	0.516
02020	38	34	3.2	--	0.594
02014	38	34	3.5	--	0.647
02015	40	20	2	--	0.313
02033	40	35	3	--	0.583
02025	45	27	1.2	--	0.229
02017	47	15	1.5	--	0.245
02044	50	25	3	--	0.583
02037	53	20	3	--	0.567
02042	55	28	2	--	0.437
02053*	57	45	3	1	0.802
02012	60	18	6	--	1.166
02003	66.5	44.5	4	--	1.156
02046	68	29	2	--	0.512
02002	70	25	2	--	0.502
02004	75	50	3	--	0.988
02043	76.2	25.4	3	--	0.799

Aluminium Tubes

Standard Profiles

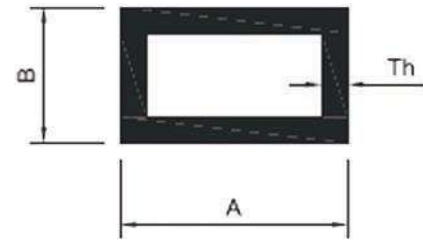
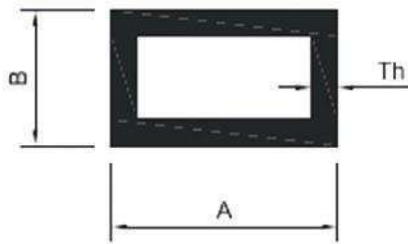

Profile Reference	A mm	B mm	Th mm	Corner Radius	Kg. / m.
05070	20	10	1.2	--	0.179
05153	20	10	1.5	--	0.218
05108	20	15	1.2	--	0.211
05177	24	15	1.5	--	0.291
05168	25	10	1.8	--	0.305
05146*	27.5	14	1.8	2	0.359
05035	40	20	1.1	--	0.345
05016	40	20	1.4	--	0.433
05008	40	20	1.8	--	0.550
05144*	40	20	2	2	0.596
05112	40	20	2.5	--	0.743
05100	40	26	3.2	--	1.030
05111	46	20	2.5	--	0.824
05064	50	15	1.5	--	0.502
05157	50	20	3	--	1.036
05117	50	25	1.1	--	0.432
05017	50	25	1.4	--	0.546
05145*	50	30	1.8	1.8	0.735
05189	50.8	25.4	3.25	--	1.223
05125	54	25	1.5	--	0.616
05137	55	35	1.7	--	0.795
05105	55	45.5	3	--	1.530
05007	60	20	1.5	--	0.624
05194*	60	25	2	2	0.866
05018	60	30	1.4	--	0.660
05166	60	30	3	--	1.360
05044	60	40	1.6	--	0.836
05002	60	40	2	--	1.037

Profile Reference	A mm	B mm	Th mm	Corner Radius	Kg. / m.
05130	90	40	2	--	1.361
05148*	90	53	4	2	2.907
05173	93.2	59	2	--	1.600
05106	94	55	3	--	2.315
05140	95	25	1.7	--	1.070
05104	95.4	55	3	--	2.338
05086*	98	61	4	1	3.259
05120	100	15	1.15	--	0.700
05090	100	15	1.2	--	0.730
05075	100	15	1.35	--	0.819
05089	100	20	1.2	--	0.762
05084	100	20	1.3	--	0.824
05037	100	20	1.445	--	0.914
05009	100	20	2	--	1.264
05050	100	30	2.5	--	1.688
05038	100	40	1.33	--	0.991
05029	100	40	1.5	--	1.110
05004	100	40	2	--	1.469
05135	100	40	3	--	2.170
05006	100	45	1.8	--	1.374
05007*	100	45	2.5	1	1.900
05025*	100	45	3.5	1	2.609
05074	100	50	1.6	--	1.270
05151	100	50	2	--	1.577
05058	100	50	2.5	--	1.958
05033*	100	50	3.45	0.75	2.666
05026*	100	60	4	1.25	3.283
05042	100	70	1.65	--	1.485

Aluminium Tubes

Standard Profiles

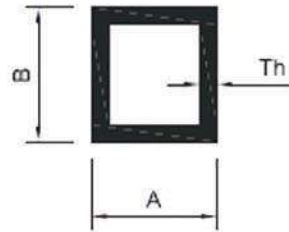

Profile Reference	A mm	B mm	Th mm	Corner Radius	Kg. / m.
05147*	14	14	1.7	1.5	0.221
05051	19.5	19.5	1.7	--	0.327
05113	20	20	1.25	--	0.253
05047*	24	24	1.2	1	0.293
05028*	25	25	1.2	1	0.307
05063	25	25	1.5	--	0.381
05027*	25	25	1.7	1	0.426
05055	30	30	1.5	--	0.462
05085	30	30	2	--	0.605
05159	30	30	3	--	0.874
05068*	30	30	5	1	1.352
05143	35	35	1.1	--	0.403
05052	35	35	1.3	--	0.473
05049	35	35	1.4	--	0.508
05136	35	35	1.7	--	0.611
05123	40	40	0.9	--	0.380
05141	40	40	1	--	0.421
05122	40	40	1.1	--	0.462
05039	40	40	1.16	--	0.486
05034	40	40	1.2	--	0.503

(*) denotes profile with corner radius / 'V' groove
Check before order confirmation.

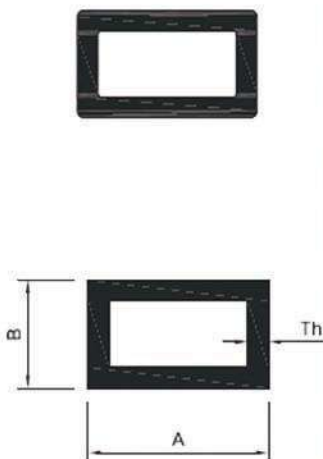

Profile Reference	A mm	B mm	Th mm	Corner Radius	Kg. / m.
05191	190	40	3	--	3.710
05154	200	50	3	--	3.952
05155*	200	50	6	6/2	7.637
05110	200	80	3	--	7.637
05110	200	80	3	--	4.438
05158	200	100	6.5	--	4.763
05186	200	100	3	--	4.763
05186	200	100	6.5	--	10.074
05172	200	150	3	--	5.572
05156	233	50	3	2	4.487
05149	250	75	3	--	5.167
05180	250	100	6	--	10.951
05171*	250	150	3	1	6.380
05195	300	100	3	--	6.383
05161*	300	200	4	1	10.627
05179	380	100	6	--	15.163

Aluminium Channels

Standard Profiles

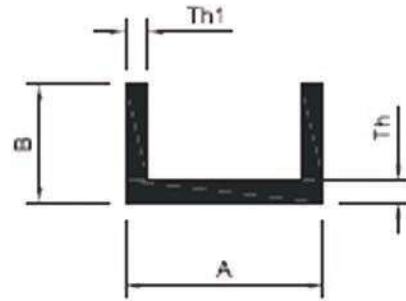
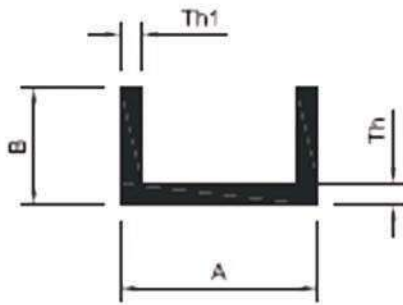

Profile Reference	A mm	B mm	Th mm	Th1 mm	Corner Radius	Kg. / m.
03092	6.6	10	1.2	1.2	--	0.077
03100	8.4	13	1.2	1.2	--	0.103
03088	9.	12	1.5	1.5	--	0.121
03082	10.2	12.1	1.6	1.8	--	0.146
03042	11.5	13	2.5	1.5	--	0.163
03067	12	9	1.2	1.2	--	0.089
03112	12	23	2	2	--	0.292
03029	12.3	19	3	1.3	2	0.207
03005	13	19.1	1.8	1.8	--	0.231
03054	14	15	1.5	1.5	--	0.166
03091	15	10	1.2	1.2	--	0.105
03105	15	35	2.25	2.25	--	0.489
03060	16.5	19.5	1.2	1.2	--	0.171
03052	17	17	1.5	1.5	--	0.194
03031*	17.5	35	4	3.25	1	0.732
03006	18	20	2	2	--	0.292
03071	18	40	4	4	--	0.972
03063	18.8	12.5	1	1	--	0.113
03062	19	12.5	2	2	--	0.216
03061	20	12	2	2	--	0.216
03080	20	20	1.3	1.3	--	0.201
03001	20	20	2	2	--	0.302
03007*	20	30.5	3	3.5	1	0.674
03059	21	9.25	1.15	1.15	--	0.116
03038	23	15	1.2	1.2	--	0.164
03041	23	21.5	1.5	1.5	--	0.255
03040	24.8	15	1.4	1.4	--	0.197
03064	25	12	1.3	1.3	--	0.163

Profile Reference	A mm	B mm	Th mm	Th1 mm	Corner Radius	Kg. / m.
03073	44	20	2	2	--	0.432
03016	45	20	1.5	1.5	--	0.308
03011	45	60	2	2	--	0.870
03025	46	10	2.5	2.5	1.5	0.409
03074*	48	90	12	12	1	6.606
03022	50	10.5	1.6	1.25	--	0.276
03024	50	16.6	1.6	1.6	--	0.346
03070	50	25	2	2	--	0.518
03023	50	50	3	3	--	1.167
03046	55	20	1.8	1.8	--	0.444
03034	55	35	5	5	3	1.528
03028	56	20	2.5	2.5	--	0.614
03079	56	30	2.5	2.5	--	0.749
03026	58	40	1.5	1.5	--	0.547
03010	59	38	3	3	3	1.045
03056	60	12	1.5	1.5	--	0.328
03045	60	20	4	4	--	0.994
03093	60	30	3	3	--	0.923
03014	66	30	3	3	--	0.975
03036	80	40	2	2	--	0.842
03090*	81.5	21.4	1.55	2.1	1/2	0.561
03055	94	15	3	3	--	0.956
03015	94.25	40	2	2	2	0.923
03035	100	40	1.65	1.65	--	0.787
03020	100	40	4	4	--	1.858
03078	100	45	5	5	--	2.722
03004	101.6	41.45	1.8	1.8	--	0.880
03003	102	50	3	3	--	1.588

Aluminium Round Pipes

Standard Profiles

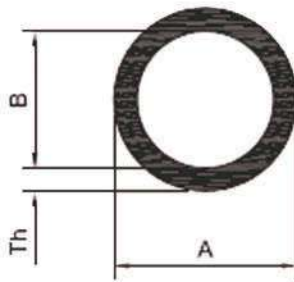

Profile Reference	A mm	B mm	Th mm	Kg. / m.
06103	8	5.8	1.1	0.064
06083	9.6	6.2	1.7	0.114
06106	10	7.4	1.3	0.096
06045	12	10	1	0.093
06017	12	9	1.5	0.134
06075	13.5	10	1.75	0.174
06008	17	14	1.5	0.200
06019	18.5	15.5	1.5	0.216
06053	19	16.4	1.3	0.195
06054	22	19.4	1.3	0.228
06001	22	19	1.5	0.265
06055	25	22.4	1.3	0.261
06034	25	21	2	0.390
06021	25	17	4	0.713
06078	27	13	7	1.187
06056	28	25.4	1.3	0.294
06082	28.4	24.4	2	0.447
06110	30	27.2	1.4	0.340
06025	30	26.4	1.8	0.431
06059	30	25	2.5	0.583
06088	31.5	7.5	12	1.985
06068	33	28	2.5	0.647
06039	33	27	3	0.763
06012	33.5	25.5	4	1.001
06024	35	31.4	1.8	0.507
06081	35	29	3	0.814
06117	38	34	2	0.611
06035	38.1	31.5	3.3	0.974

Profile Reference	A mm	B mm	Th mm	Kg. / m.
06023	40	36.4	1.8	0.583
06007	40	34	3	0.950
06004	40	20	10	2.600
06013	45	40.5	2.25	0.816
06005	48	40	4	1.492
06101	48.5	42.5	3	1.158
06102	48.5	32.9	7.8	2.693
06072	48.6	40	4.3	1.616
06010	50	46	2	0.817
06011	50	45	2.5	1.011
06016	50	44	3	1.196
06014	51	45.5	2.75	1.126
06036	51	38.1	6.45	2.437
06080	51.4	45.4	3	1.231
06020	53.5	49.5	2	0.874
06060	60	56	2	0.984
06006	60	54	3	1.460
06037	60	52.3	3.85	1.834
06079	60	52	4	1.900
06002	60	36	12	4.900
06046	60.32	49.24	5.54	2.574
06061	63	58	2.5	1.283
06062	70	65	2.5	1.431
06026	73.1	60.4	6.35	3.595
06029	75	69	3	1.832
06069	75	65	5	2.969
06015	75	64	6	3.563
06018	77.3	73.3	2	1.287

Aluminium Flat Bars

Standard Profiles

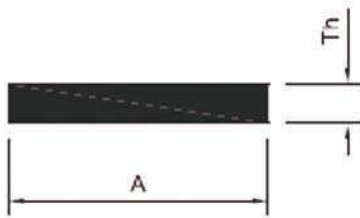

(*) denotes profile with corner radius / chamfer
Check before order confirmation.

Profile Reference	A mm	Th mm	(R)Corner Radius	Kg. / m.
07044	10	2	--	0.054
10295	15.8	12.7	--	0.542
07010	16	3	--	0.130
07045	20	2	--	0.108
07020	20	3	--	0.162
07007	20	5	--	0.271
07014*	20	5	1	0.268
07023	20	8	--	0.432
07061	20	10	--	0.539
07034	27	4	--	0.292
07036	30	3	--	0.243
07015*	30	5	1	0.403
11300	30	20	--	1.620
07053	31	12	--	1.004
07012	32	2	--	0.173
07005	32	5	--	0.432
07051	34	5	--	0.458
07048	34	12	--	1.101
07029	40	2	--	0.216
07019	40	3	--	0.324
07002	40	4	--	0.435
07008	40	6	--	0.648
07035	40	8	--	0.864
07032	40	12	--	1.296
07011	40	20	--	2.160
07057	45	3	--	0.364
07058*	45.5	8	2	0.973
07013	47.5	2	--	0.257

Profile Reference	A mm	Th mm	(R)Corner Radius	Kg. / m.
07059	50	1.5	--	0.202
07016*	50	3	1.5	0.400
07001	50	4	--	0.540
07026	50	6	--	0.810
07027	50	10	--	1.350
07054	54	8	--	1.166
07049	57	12	--	1.846
07050	57	17	--	2.616
07003	59.8	8	--	1.296
07030	60	3	--	0.486
07031	60	5	--	0.810
07009	60	6	--	0.972
07021	75	4	--	0.810
07056*	75.5	8	2	1.622
07025	80	8	--	1.728
07052	80	10	--	2.159
07046*	82	2	1	0.441
07047*	91	3	1.5	0.734
07071	100	3	--	0.810
07070	100	6	--	1.620
07039	100	8	--	2.159
07004*	100	12	2	3.218
07033	100	20	--	5.400
07069	110	5	--	1.485
07060	110	10	--	2.969
07062	115	6	--	1.862
07073	120	10	--	3.240
07041	130	8	--	2.807

Aluminium Flat Bars

Standard Profiles

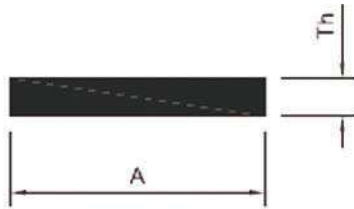

(*) denotes profile with corner radius / chamfer
Check before order confirmation.

Profile Reference	A mm	Th mm	(R)Corner Radius	Kg. / m.
22750*	135	20	1	7.288
22101	140	15	--	5.669
07017*	150	6	1	2.428
07018*	150	8	1	3.238
07028*	150	11	1	4.453
07006*	150	12.7	3	5.144
07055*	150	13	1	5.263
07072	170	6	--	2.753
23311*	170	20	1	9.177
22751*	180	30	1	14.578
07038	200	5	--	2.700
07040	200	6	--	3.240
07037*	200	9	1	4.860
07022*	200	15	1	8.098
07024*	200	20	2	10.791
07042	300	20	--	16.200
07043	300	30	--	24.299

Aluminium Solid items

Standard Profiles

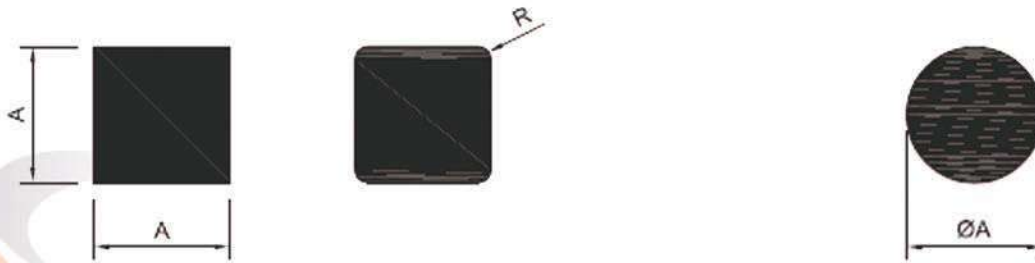

(*) denotes profile with corner radius / chamfer
Check before order confirmation.

Profile Reference	A mm	(R)Corner Radius	Kg. / m.
10707	9.8	--	0.259
22603	12	--	0.388
09692	15	--	0.608
11613	20	--	1.080
10018*	20	2	1.071
11552*	25	0.75	1.689
09336*	28.2	3	2.150
10111*	45	2	5.458
22424	50.8	--	6.967
09442	70	6	13.168

Profile Reference	Ø A mm	Kg. / m.
21119	6.5	0.090
11012	8	0.136
21912	10	0.233
21703	12	0.305
11297	20	0.848
21045	30	1.909
21509	50	5.301
24114	60	7.634
24115	80	13.572
24112	90	17.177
21507	105	23.379
24113	110	25.659

Aluminium Sheets

Aluminium Sheets

SlNo	Item Code	Description (ALUMINIUM SHEETS)
1	AS 1	ALUM PLAIN SHEET 0.5MM (8`X4`)
2	AS 2 B	ALUM PLAIN SHEET 0.65 MM (8`X4`)
3	AS 2	ALUM PLAIN SHEET .7 MM (8`X4`)
4	AS 3 B	ALUM PLAIN SHEET 0.85 MM (8` X 4 `)
5	AS 3 H	ALUMINIUM PLAIN SHEET 0.9 MM
6	AS 3 A	PLAIN SHEET 1 MM
7	AS 4 A	ALUM PLAIN SHEET 1.1 MM (8`X4`)
8	AS 4 B	ALUM PLAIN SHEET 1.1 MM (5' X 10')
9	AS 4	ALUMINIUM PLAIN SHEET 1.2 MM
10	AS 5	ALUM PLAIN SHEET 1.4 MM (`8 X4`)
11	AS 5 E	ALUM PLAIN SHEET 4 ` x 10 x 1.4 mm
12	AS 5 C	ALUM PLAIN SHEET 5`x 10 ` x 1.4 MM
13	AS 5 H1	ALUM PLAIN SHEET 4 X 8 X 1.5 MM
14	AS 6	ALUM PLAIN SHEET 1.8 MM (`8 X 4`)
15	AS 6 C	ALUMINIUM PLAIN SHEET 1.80 MM (4 ` X 10)
16	AS 6 B	ALUMINIUM PLAIN SHEET 1.8 MM (5' X 10')
17	AS 6 A	ALUMINIUM PLAIN SHEET 2 MM (8` X4`)
18	AS 6E	ALUMINIUM PLAIN SHEET 2.5 MM (4 X 8)
19	AS 2.5	ALUMINIUM SHEET 2.5 MM (5 ' X 10 ')
20	AS 7	ALUM PLAIN SHEET 2.8 MM (8`X4`)
21	AS 7A	ALUM PLAIN SHEET 2.8 MM (4' X 10')
22	AS 7B	ALUM PLAIN SHEET 5 X 10 X 2.80MM
23	AS 11	ALUMINIUM PLAIN SHEET 3.0 MM (8 x 4')
24	AS 7C	ALUM PLAIN SHEET 3.0 MM (10`X5`)
25	AS 8	ALUM PLAIN SHEET 3.8 MM (8`X4`)
26	AS 8B	ALUM PLAIN SHEET 3.8 MM (10' X 5')
27	AS 9	ALUM PLAIN SHEET 4.8 MM (8`X4`)
28	AS5	ALUMINIUM PLAIN SHEET 4.8 MM (5 ' X 10 ')
29	AS 10	ALUM PLAIN SHEET 5.8MM (8 X 4)
30	AS 10 1	ALUM PLAIN SHEET 5.8MM (5 X 10)
31	AS 14	ALUM SHEET 8MM (8`X4`)
32	AS11	ALUMINIUM PLAIN SHEET 10 MM (8`X4`)
33	AS11 A	ALUMINIUM PLAIN SHEET 10 MM (5 X 10)
34	AS 12	ALUM PLAIN SHEET 11.8 MM (8`X4`)
	AS 16	ALUM.PLAIN SHEET 15.8MM
35	AS 10 A	ALUM.PLAIN SHEET 20 MM (8`X 4`)
36	AS 25	ALUM.PLAIN SHEET 24.8MM (8`X 4`)
37	AS 30 A	ALUMINIUM PLAIN SHEET 29.8 MM

INTERNATIONAL TRADING LLC

SIRAJCO



Aluminium Chequered Plates

Aluminium Chequered Plates

SINo	Item Code	Description ALUMINIUM CHEQUERED SHEETS
1	ACS 1BS	ALUM CHEQ-SHEET 1.00 MM BASE (8'X4')
2	ACS 1G	ALUM CHEQUER SHEET 1.8 MM BASE (8'X4')
3	ACS 2G	ALUM CHEQ SHEET 2.00 MM BASE (8' X 4')
4	ACS 3G	ALUM CHEQ SHEET 2.5 MM BASE (8' X 4')
5	ACS 3C	ALUM CHEQ- SHEETS 2.80 MM BASE (8 ` X 4 `)
	ACS 4G	ALUMINIUM CHEQUER SHEET 3.0 MM X (8 ` X 4 `)
6	ACS 5CG	ALUM CHEQ SHEET 3.50 MM BASE (8 X 4)
7	ACS 5G	ALUM CHEQ SHEET 4.00MM BASE (8' X 4')
8	ACS 7	ALUM.CHEQ SHEET 5.0 MM BASE (8'X4')
9	ACS 7A	ALUM CHEQ SHEET 5.80 MM BASE (4'X8')
10	ACS 8	ALUM CHEQ SHEET 8.0 MM BASE (8'X4')



TEL : +971 4 33345 33

FAX : +971 4 3334359

sirajco@emirates.net.ae

www.sirajcointernational.com/trading-division

LINKEDIN : SIRAJCO INTERNATIONAL TRADING L.L.C
