

الكوثر للأعمال الصحية ذ.م.م

AL KAWTHER SANITARY WORKS L.L.C



FABRICATED
PLUMBING PRODUCTS



AL KAWTHER SANITARY WORKS L.L.C

☎ 02-5508211, 02-5508212 📱 055 594 8211, 052 762 8212 📞 052 811 4849, 050 971 8211

🐦 @al_sanitary 🌐 AL Kawther Works 📷 _alkawther_ 📺 alkawther Abudhabi ✉ alkawtherworks@gmail.com 🌐 www.alkawtherfab.com

INTRODUCTION

We are pleased to introduce ourselves

Al Kawther Sanitary Works L.L.C is a specialist in PVC and GRP Fabrication The company has been operational since 2011 and has been associated with many prestigious projects catering to their needs for quality products.

We have a comprehensive products range readily available to satisfy the needs of our customers.

We are committed to quality and fully understand the needs of the users.

Some of the prestigious projects that we have been associated with in the UAE includes Jabel Ali Airport, JAFZA Convention centre, Jumeirah Lake Tower, Dubai Health Care, Burj Dubai Lake Hotel, Nakheel Projects and many more.

We have qualified technical team and always available to assist for any kind of technical issues and ready to visit the sites if required.

PRODUCT LIST

- Grease Traps (Type ABC & D)
- Electrical & upvc long radius bend
- Dry Manholes (As per Drawing)
- Cross Tee & Y Branches
- Different types of Funnels
- Blank Flanges
- Street Light Conduit Bends
- Catch Basins
- End caps up to 400mm
- Grease Interceptors, Oil Traps
- Gully Traps (Road Gully, Dry Gully)
- Ramp Trench Gully Drain
- High Pressure Non standard fittings (with GRP coating)
- Reducer Y&T-Branches
- Pressure Headers
- Different type Offsets
- Threaded Adaptors, Push fit Adaptors
- Solvent Coupler & Repair Coupler
- Pressure Breaking Chamber
- Sand Trap Buckets
- Perforated Flange Pipes & Sockets
- Stack Drain Speed Breakers
- Soak way, Silt Buckets
- Slotted Land Drain Pipes
- Puddle Flanges (with/without gritting)
- Reducers, Sockets and Bell Mouths

MATERIAL USING FOR FABRICATION

**Hepworth
National Plast**

**Cosmoplast
Terrain**

**Anabeeb
Atlas**

**Polyfab
Power Plast**



**GREASE TRAP A
(HOME KITCHEN & VILLAS)**

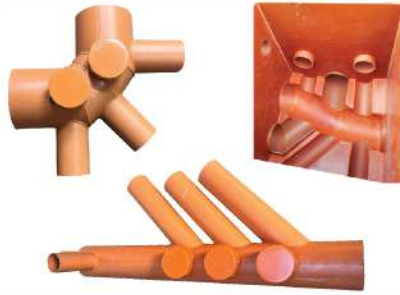

**UPVC DRY MANHOLE &
MANHOLE BENCHING**



**PUDDLE FLANGE
(PVC, HDPE, PPR)**



GREASE TRAP B



CATCH BASIN



**PVC FABRICATED TEST
PIG (MANDREL)**



GREASE TRAP C



GULLY TRAPS

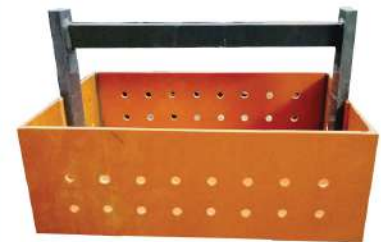

SAND TRAP BUCKET



GREASE TRAP D



LONG RADIUS BENDS



FABRICATED COUPLER



SS GREASE TRAP AG1,2,3

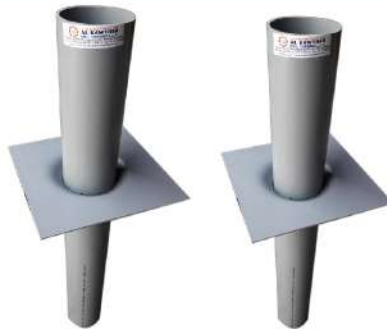

PERFORATED FLANGE



FABRICATED END CAPS



SS PUDDLE FLANGE



HDPE FABRICATED DMH



HDPE DRY GULLY TRAP



FABRICATED FITTINGS



HDPE FABRICATED GULLY TRAP



BELL MOUTH FLANGES



**PVC HEADER &
PVC CHANNEL GRATING**



SOAK WAY FIT



ANTI VORTEX PLATE



ROAD GULLY



PVC STREET LIGHT BEND



GRP LAMINATED FITTINGS



GRP SEALING PLATE



GI PUDDLE FLANGE



SLOTTED LAND DRAIN PIPES



FABRICATED CROSS TEE



REPAIR COUPLER RR



FABRICATED PVC SADDLE



FABRICATED AIR VENT



FABRICATED CROSS TEE RR



PVC THREADED PIPE



uPVC BELL MOUTH SOCKET

Bell mouth with puddle flange

Socket End Belt Dimension

Spigot End Belt Dimension

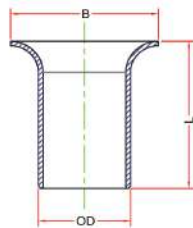
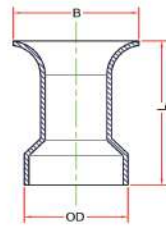
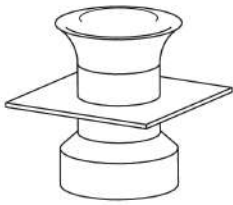

ISOMETRIC VIEW

SECTIONAL VIEW

SECTIONAL VIEW

OD (Inch)	OD (mm)	LENGTH (L) (mm)	BELL END (B) (mm)
4	114.1	250	145
6	168.0	250	190
8	218.8	300	265
10	272.6	400	330

GREASE TRAP - B

Note: The dimensions can be altered to suit specific requirements

uPVC PUDDLE FLANGE

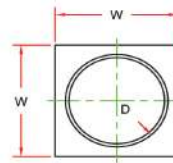

TOP VIEW

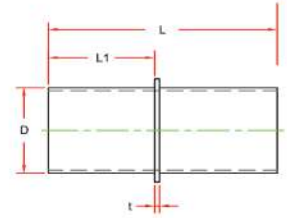

FRONT VIEW

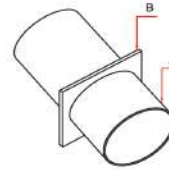

ISOMETRIC VIEW



Note: The dimensions can be altered to suit specific requirements

uPVC SAND TRAP

Dimensions:

A	: mm
B	: mm
C	: mm
D	: mm
E	: mm

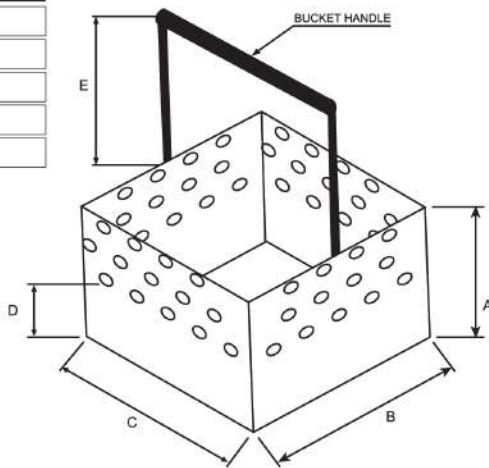

LONG RADIUS BEND

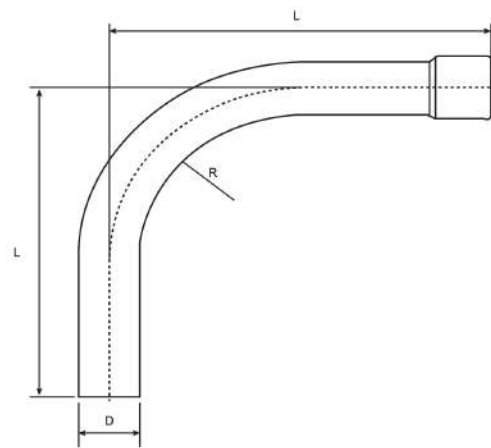

Pipe Size (OD - MM)	Radius - R (MM)	Angle

Socket Type : Solvent

GULLY TRAP

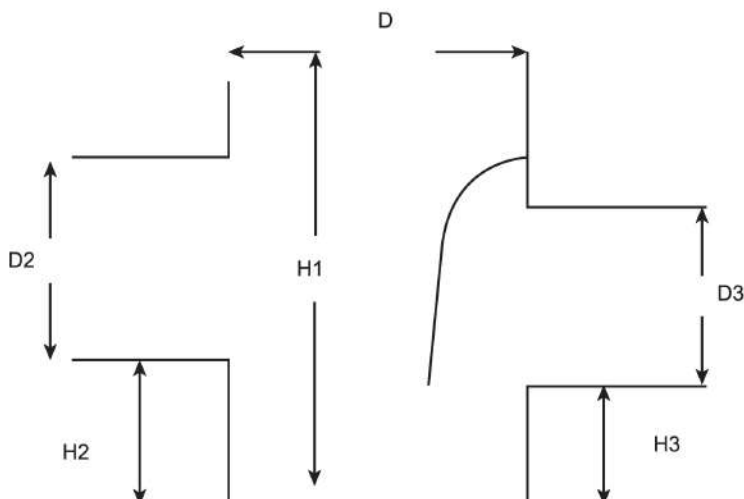

Specifications:

D	: mm
D2	: mm
D3	: mm
H1	: mm
H2	: mm
H3	: mm

Requires

Separator :

- D2 Side
- D3 Side

Top Cover:

- Grated Cover
- Close Cover with Bolts and Nuts



SCAN ME

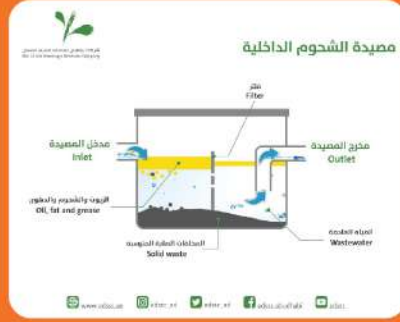

الكوثر للأعمال الصحية ذ.م.م

AL KAWTHER SANITARY WORKS L.L.C

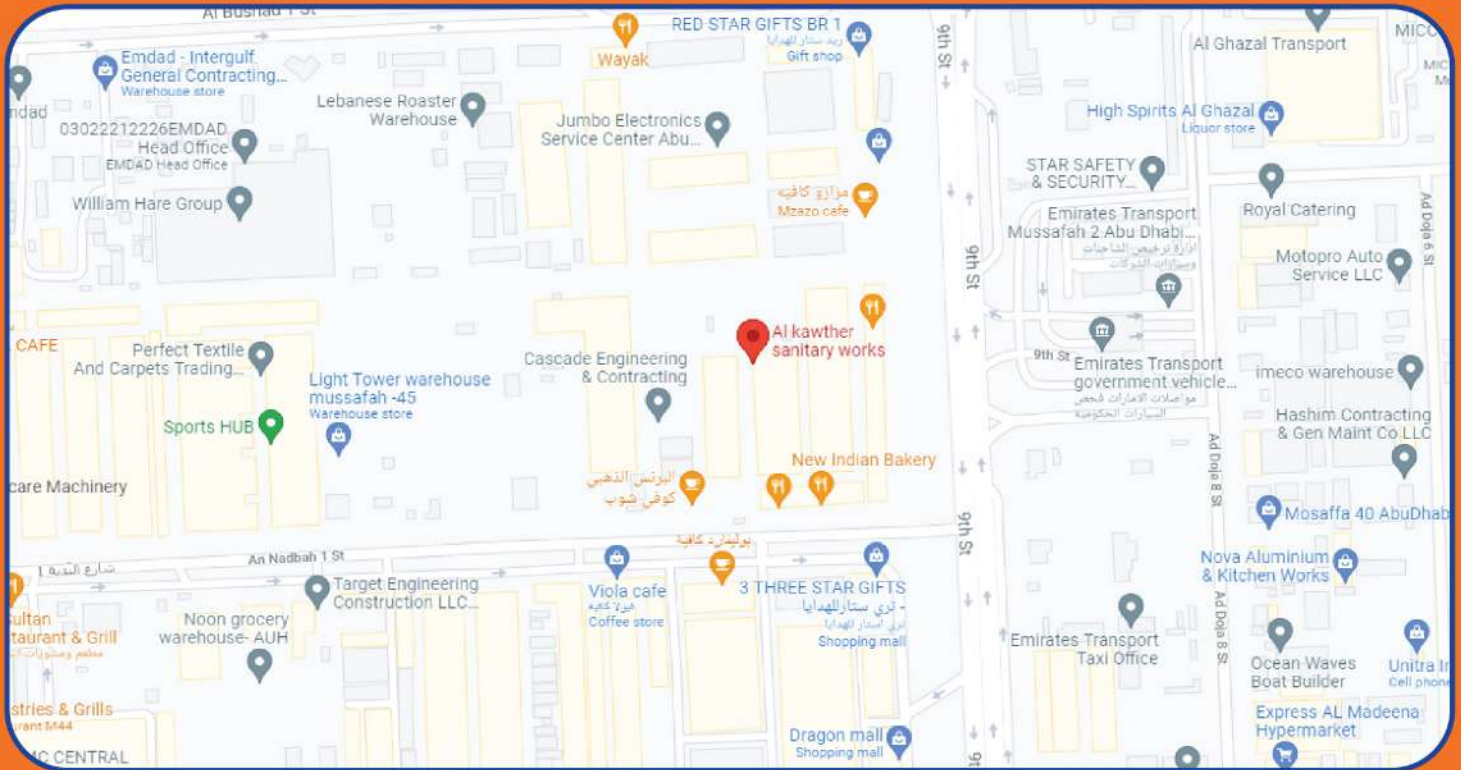

AL KAWTHER SANITARY WORKS L.L.C

P.O. No: 93077, Plot No.8, Store No.50, Near Three Star Gift Market
Mussafah M-45, Abu Dhabi - U.A.E.

Mobile: +971 52 820 5636, Tel. No.: 02-5508211, 02-5508212

E-mail: alkawtherworks@gmail.com | Web: www.alkawtherfab.com