

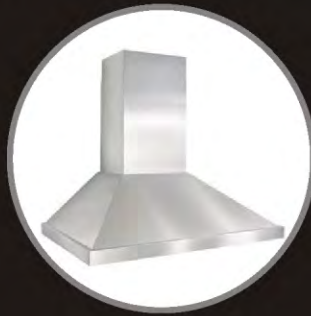

البستان مطابخ

AL-BUSTAN  
KITCHENS



STEEL FABRICATION

KITCHEN EQUIPMENTS

SS TROLLY  
KITCHEN CABINETS  
INDUSTRIAL AIR DUCTS.



# AL BUSTAN KITCHENS

Specialist All Kinds of Stainless Steel  
Kitchen Equipments Works

- Stainless Steel Fabricator,
- Stainless Steel Kitchen Equipment's,
- Blower Fans,
- Kitchen Exhaust Fans,
- G.I Duct Fabrication,
- Duct Fixing,
- S.S Commercial Kitchen Equipment's,
- Stainless Steel Hood,
- Stainless Steel Table,
- Stainless Steel Cabinets,
- Stainless Steel Sinks,
- Stainless Steel Handrail,
- Stainless Steel Cladding,
- Stainless Steel Shelf,
- Stainless Steel B.B.Q Grill Set,
- Stainless Steel Bollard,
- Stainless Steel Hot Grill/Plate,
- Stainless Steel Tandoor,
- Stainless Steel Upright Cabinets,
- Ecology Unit,
- Stainless Steel Duct,
- Aluminium Cladding,
- Bakery Equipment's,
- Stainless Steel Safety Guards,
- Stainless Steel Parking Pole,
- Stainless Steel Canopy,
- Stainless Steel Double Skin Hoods,
- Stainless Steel Single Skin Hood,
- Kitchens Equipment's,
- Steel Fabrication,
- Stainless Steel Sink Top Cabinet,
- Stainless Steel Single Bowl Sink,
- Stainless Steel Double Bowl Sink



**BS3FDUC/F (G-83)  
Upright S/S 3 Door  
Chiller/Freezer  
with blower system**



**Technical specifications:**  
**Made in Malaysia**

CAP: 1980 L  
POWER: 230V-50HZ, 845W (CHILLER)  
1500W (FREEZER)  
TEMP: 2C TO 8C (CHILLER)  
10C TO -20C (FREEZER)  
DIM: 2010x830x2060 MM  
WEIGHT: 250 KG

Available single or double door

**BS3FDUC/F (G-83)  
Upright S/S Double Door  
Chiller/Freezer  
with blower system**



**Technical specifications:**  
**Made in Malaysia**

CAP: 1400 L  
POWER: 230V-50HZ, 480W  
(CHILLER), 1000W (FREEZER)  
TEMP: 2C TO 8C (CHILLER)  
10C TO -20C (FREEZER)  
DIM: 1480x830x2060 MM  
WEIGHT: 196 KG

Available single door

**MBF 811 7/4  
Upright S/S Double Door  
Chiller/Freezer**



**Technical specifications:**  
**Made in China**

CAP: 1200 L  
POWER: 220V-50HZ  
1/4 HP-389W (CHILLER)  
3/4 HP-813W (FREEZER)  
TEMP: 3/4 HP-813W (FREEZER)  
1C TO 8C (CHILLER)  
COOLING STYLE: 17C TO -20C (FREEZER)  
DIM: 1314x845x2100 MM  
WEIGHT: 200 KG

Available single door

**Avalon (AF-14SIR)  
S/S Double Glass Door  
Chiller/Freezer**



**Technical specifications:**  
**Made in Italy**

CAP: 1400 L  
POWER: 569W (CHILLER)  
931W (FREEZER)  
TEMP: 0 TO 10 C (CHILLER)  
18 TO -20C (FREEZER)  
DIM: 1440x810x2050 MM  
THICKNESS: 60 MM  
WEIGHT: 190 KG

Available single door

**ANDROMEDA (AF07IR)  
S/S Single Door  
upright Chiller/Freezer**



**Technical specifications:**  
**Made in Italy**

CAP: 700 L  
POWER: 345W (CHILLER) 640W  
(FREEZER)  
TEMP: 0 TO 10 C (CHILLER)  
18 TO -20C (FREEZER)  
DIM: 715x810x2050 MM  
THICKNESS: 60MM  
WEIGHT: 150 KG

Available Double door

**1D-DC/F S  
Painted Upright  
Single Glass Door  
Chiller/Freezer**



**Technical specifications:**  
**Made in Malaysia**

CAP: 444 L, 5 SHELVES  
POWER: 220/230V-50/60HZ  
TEMP: 2C TO 8C (CHILLER)  
10C TO -20C (FREEZER)  
DIM: 635x (710+50) x2060 MM  
WEIGHT: 95 KG

Available Double door

**SL02C6VR4**  
**Double Doors Saladette**  
**6 Drawers**



*Technical specifications:*  
*Made in Italy*

With granite working top and refrigerated display

CAP: 220 L  
POWER: 1410x700x1525 MM  
TEMP: +4/+10  
WEIGHT 245 KG

Available single or double door

**ESL-3850**  
**Three Door Sliding Lid**  
**Sladette**



*Technical specifications:*  
*Made in China*

CAP: 380 L  
POWER: 220V/50HZ, 1/3 HP  
TEMP: +2 TO +8C  
COOLING STYLE: STATIC  
DIM: 1365x700x850 MM

Available single door

**THV 2000/380**  
**Top Salad Bar**



*Technical specifications:*  
*Made in China*

NO # 9 GN 1/3 PANS  
DIM: 2000x395x435 MM

Available single door

**BCC-4**  
**SUSHI COUNTER**



*Technical specifications:*  
*Made in Spain*

CAP: 4x1/3 GN  
POWER: 330W  
TEMP: 4C TO 8 C  
DIM: 1050 X 415 MM  
WEIGHT: 33 KG

Available single door



**BS2D-C/F 44**  
**S/S Double Counter**  
**Chiller/Freezer**



**Technical specifications:**  
**Made in Malaysia**

with 4 feet blower system  
CAP: 278 L 4 SHELVES  
POWER: 220/230V- 50/60HZ  
TEMP: 2C TO 8C (CHILLER)  
10C TO 20C (FREEZER)  
DIM 1200x(760+30)x840 MM  
WEIGHT 86 KG

- ✂ Available in different Sizes 385L & 500L
- ✂ Available 3 Door

**TAURUS Tn3**  
**S/S Three Door**  
**Under Counter Chill**



**Technical specifications:**  
**Made in Italy**

With built-in condensing unit, working table  
& with rear raiser  
CAP: 470 L  
POWER: 1/4 HP  
TEMP: 0 TO 10C  
DIM: 1820x700x855 MM  
THICKNESS: 40 MM  
WEIGHT 135 KG

- ✂ Available with 2 or 4 doors
- ✂ Available without rear raiser

**EPF 3721**  
**Two Glass Door Under**  
**Counter Chiller**



**Technical specification:**  
**Made in China**

with 4 feet blower system  
CAP: 240 L  
POWER: 220V/50HZ, 1/4 HP  
TEMP: +2 TO 10C  
FAS ASSISTED  
DIM 1390x700x850 MM

- ✂ Available in 3 Door
- ✂ Available S/S

**BS1D-PC4/C**  
**S/S Single Door**  
**Pizza Counter**



**Technical specifications:**  
**Made in Malaysia**

POWER: 230V/1/50HZ.  
TEMP: 2C TO 8C  
SIZE & NO OF FOOD PAN 5 X FP 1/3-4  
VOLUME: 188L, 2 SHELVES  
DIM: 1200x(760+30) 1080 MM  
WEIGHT: 114 KG

- ✂ Available Double or triple Door

**SINK TOPS**



**HAND WASH SINKS**



**PRE-RINSE SHOWER UNITS**



**SERVICE AND CLEANING TROLLEY**





# MISCELLANEOUS ITEMS

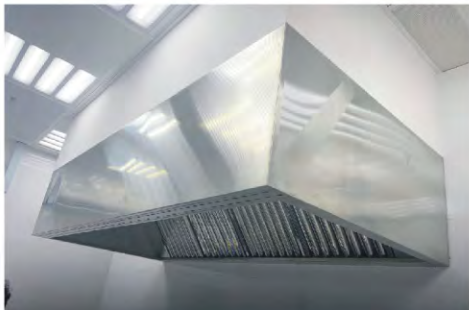
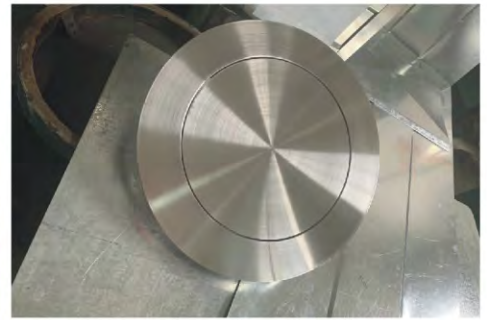



# MISCELLANEOUS ITEMS





# MISCELLANEOUS ITEMS





### S/S Table Top Shawarma Machine

Dimensions are adjustable upon request

- Single Unit
- 3 Gas Burners
- with or without hood

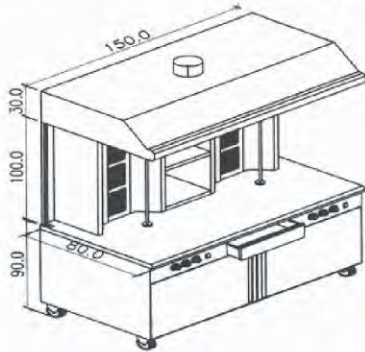

### S/S Shawarma Machine

- Single Unit
- 3 Gas Burners
- bottom cabinet with hinged doors
- with or without drawer
- with or without lightning
- with or without hood

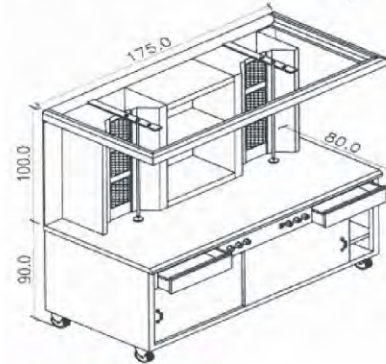
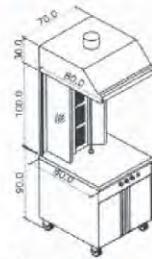

### S/S Shawarma Machine

- Double unit
- 3 Gas Burners
- Bottom cabinet with hinged doors
- or sliding doors
- One or two drawers
- with or without lighting
- with or without hood
- 2 service shelves

### S/S Shawarma Machine

- Triple unit
- 3 gas burner each, 2 gas burner in middle
- Bottom cabinet or chiller with hinged doors
- 2 drawers
- Lightning
- with or without hood

### S/S Chicken Grill Machine

- 6 Sticks
- Rotary motor
- Heat sliding glass door

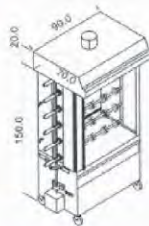

### S/S BBQ Unit

- Bottom cabinet or chiller
- with hinged doors
- with or without lightning
- with or without hood

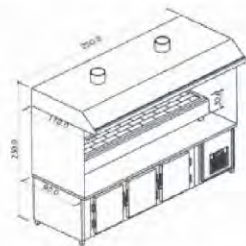

## WIRE SHELF AND TROLLEYS

### S/S Teppanyaki Grill

- With stand and bottom shelf
- infinite manual control gas value
- automatic pilot safety valve

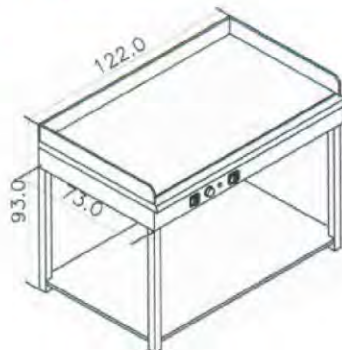

### S/S Chinese Cooker

- Gas operated
- with 2 burners
- infinite manual control gas valves
- bottom support
- splash back
- water tap
- drain hole

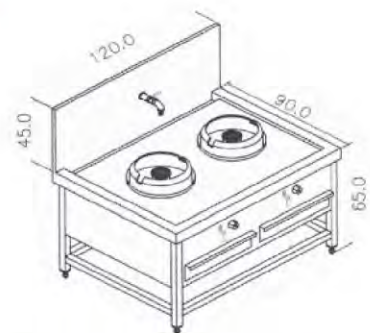



## Custom Made Ups

Dimensions are adjustable upon request

### S/S Salad Bar

- 3 to 7 GN containers
- with under counter storage
- with hinged door
- Over sneeze guard
- Tray rail
- Lightening
- Decorative glass



### S/S Meat Display Chiller

- 4 hinged doors
- Two Level Meat hang rail
- Top mounted condensing unit
- 5 cm puff installed s/s body

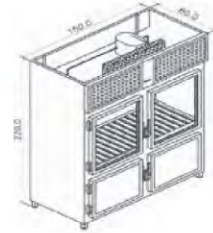

### S/S display Chiller

- Hinged Doors
- Middle shelf
- Over sneeze guard
- One glass shelf

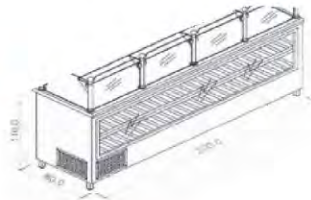

### S/S sandwich Panel Cold Room

- Made of panels 70mm thick
- Pound corners
- Condenser unit on top or side
- adjustable for normal or low temperature
- Door heater
- Pressure equalizer

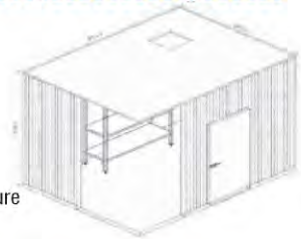

### S/S sink with stand

- Single or double bowl
- bowl size 50x50x30 cm
- bottom shelf
- back splash

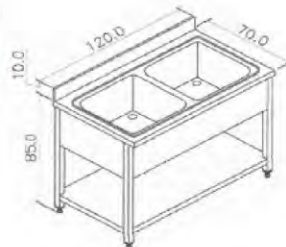

### S/S sink with stand and drain

- Single or double bowl
- right or left drain
- bottom shelf
- back splash
- bowl size 50x50x30 cm

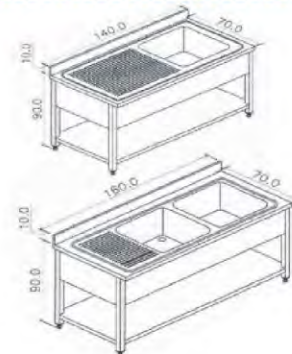

### S/S sink with cabinet and drain

- Single or double bowl
- right or left drain
- back splash
- bowl size 50x50x30 cm
- with or without drawers

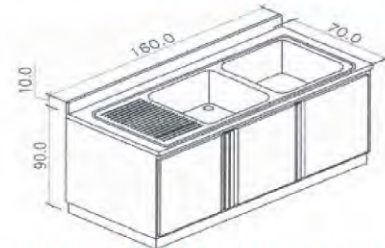
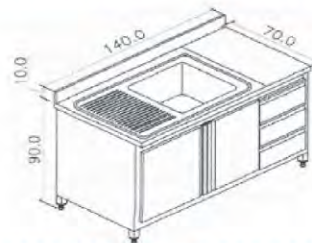

### S/S trolley

- 4 side rail for holding glass

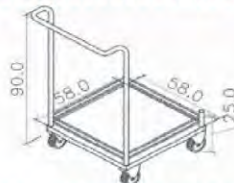

### S/S shelves trolley

- 4 side rail for holding glass



### S/S service cabinet trolley

- Tray support

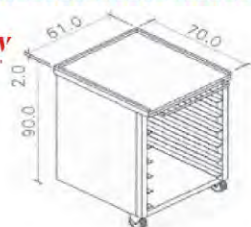

### S/S cutlery dispenser

- Middle shelf and bottom shelf





## Custom Made Ups

Dimensions are adjustable upon request

### S/S Single big bowl

- Bottom Shelf

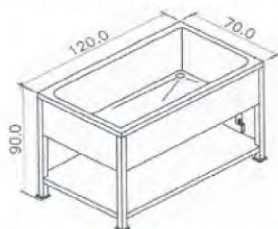

### S/S Fish Cleaning Sink

- Bottom Shelf
- Back Splash
- Plastic Chopping board

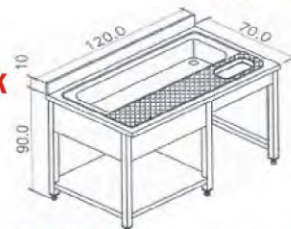

### S/S Vegetable cleaning sink

- Bottom Shelf
- Back Splash
- Perforated drain

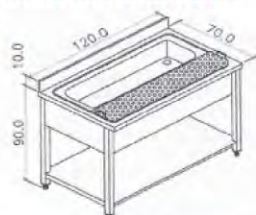

### S/S work table

- 1.5mm bottom shelf
- back splash
- reinforced and sound deadned
- adjustable legs

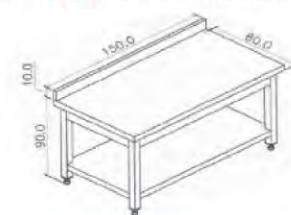

### S/S work table with cabinet

- Hinged Doors
- Middle Shelf
- Back Splash

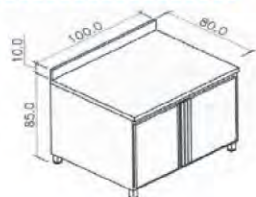

### S/S work table with sink

- Bottom Shelf
- Back Splash
- Bowl size 40x40x25 cm adjustable feet

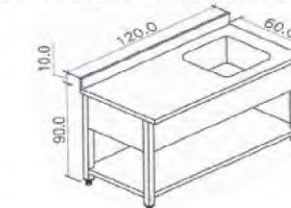

### S/S wall cabinet

- Hinged Doors
- Two Shelves
- 1.5 mm Thickness

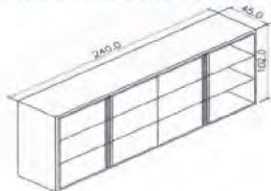

### S/S cabinet with work top

- Sliding Door
- Bottom and middle shelf



### S/S upright cabinet

- Five shelves
- 1.5 mm thickness

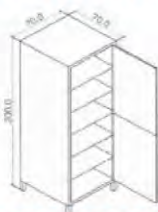

### S/S upright sheet shelving unit

- 5 Shelves
- 40x40x3 mm hollow frame



### S/S upright wire shelving unit

- 4 tire wire shelved
- Adjustable feet

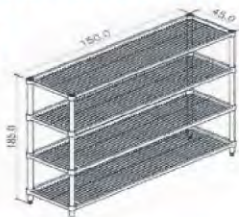

### S/S wall shelf

- With wall bracket

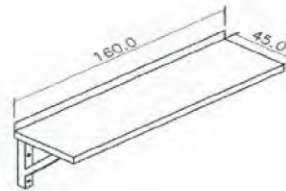

### S/S floor grating

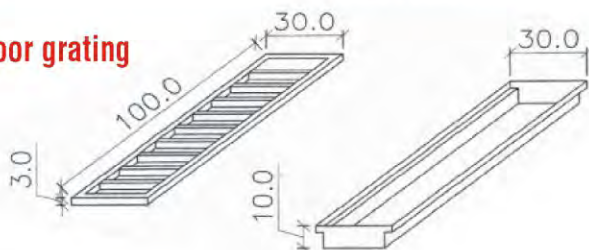

### S/S trolley

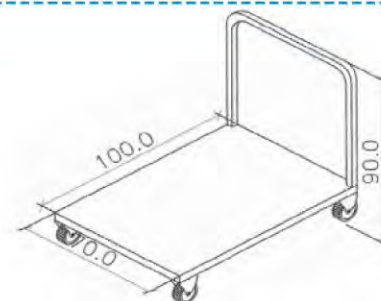



**OUR BEST**

**COMPANY PRODUCTS**



- **Stainless Steel Fabrication**
- **Stainless Steel Kitchen Equipments**
- **Industrial Rakes & Pipe Ducts**

📍 P.O Box: 145, NEW INDUSTRIAL AREA,  
AJMAN. UAE.

📞 Tel:00971-67407937

📞 00971-507346249

00971-557695605

🌐 [bustan.kitchens@gmail.com](mailto:bustan.kitchens@gmail.com)  
[www.albustankitchens.com](http://www.albustankitchens.com)