

Light
Scaffolding

All Scaffolding Supplier



www.lightscaffolding.com

BUILD WITH LIGHT SCAFFOLDING



Content

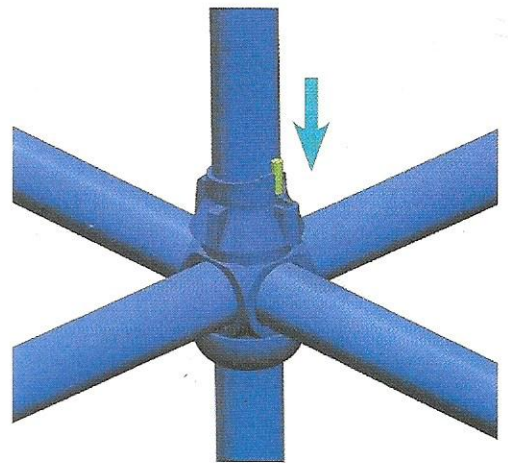
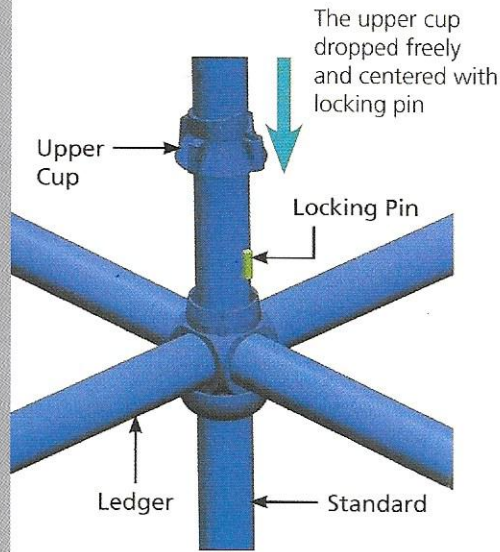

Cup Lock System
Cup Lock with Aluminium Beam
Cup Lock with H20
Wiler Steel System
Fence System
Accessories for Scaffolding



CB-037-MS

About the Establishment

Considered Light scaffolding one of the specialist in the United Arab Emirates . which provide integrated solutions and services in the field of formwork and scaffolding equipment . The factory work on the manufacturing and processing equipment formwork scaffolding, offer for sale and rent . In addition to leasing, provides specialized consulting services to many of its customers so as to ensure they receive the best safe and economic solutions for their projects



Safety

- L-Cuplock has safety built-in, as it is erected to a recognized configuration in a carefully developed sequence to work at every stage
- L-Cuplock scaffolds provide clear uninterrupted working platforms without obstructions from diagonal bracing across the deck in the majority of cases



Saving time and Cost

- L-Cuplock provides major savings in erection and dismantling durations therefore minimizes project costs

Safe working load

- Standard safe working load up to 7.50 ton according to standard unbraced length and tube wall thickness

Stair Case

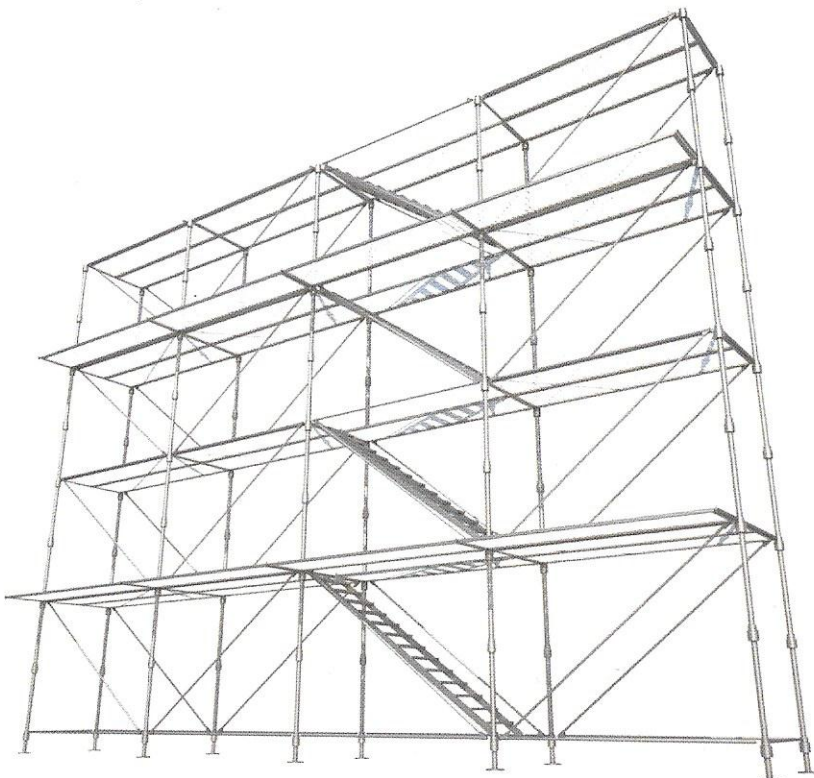

Early striking application

L-Cuplock Early Striking Application
(Supporting Floor Slabs)

L-Cuplock Early Striking System is suitable for support floor slabs through the following

- High loading capacity for standard, decking beams and
Suitable for any type of floor slab
- All components are manufactured to a very close tolerance
- All components are engineered to be light weight and easily assembled
- Early Striking save time and cost through a technique where by the formwork is removed 3 to 4 days after pouring a slab



M-Cuplock Falsework Application

(Support Structures)

L-Cuplock Falsework system is suitable for support structures applications through the following

- High standard load capacity
- Range of components that gives the system capability to tackle virtually any support application
- Formwork support wide range grid variations that can be created to suit the loading requirements and any structure types and heights
- Ability to use different types of main and secondary beams with L-Cuplock
(Timber - Aluminum - Steel)

CUPLOCK SCAFFOLD is defined as any temporary elevated work platform and its supporting structure (including points of anchorage) used for supporting employees or materials or both.
Note that there are three main points to the definition: it is elevated, it is temporary, and it supports either personnel or materials or both.

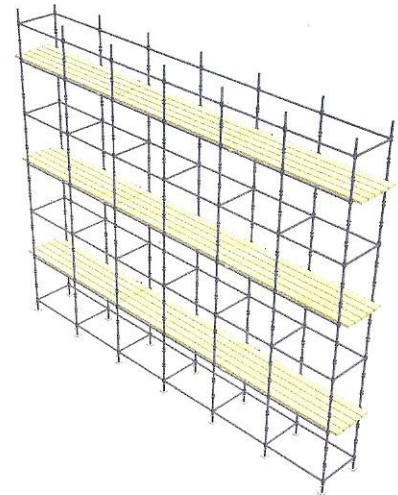
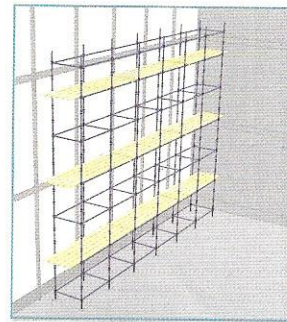

Scaffolding application

L-Cuplock Scaffolding Application

L-Cuplock scaffolding system is multipurpose steel scaffold for general access and supporting vertical loads through the following

Safe working loads on platforms will vary between 0.75kN and 3kN per square meter depending on the configuration of the scaffold

L-Cuplock scaffolding meet the requirements of the international standard for health and safety

L-Cuplock scaffolding is compatible with any scaffolding (...accessories (stairs, boards, wheels, tie

All components are designed to be light weight and easily assembled

L-Cuplock constructs and maintains an installation that can seriously affect the life acceptance and efficiency of the finished installation



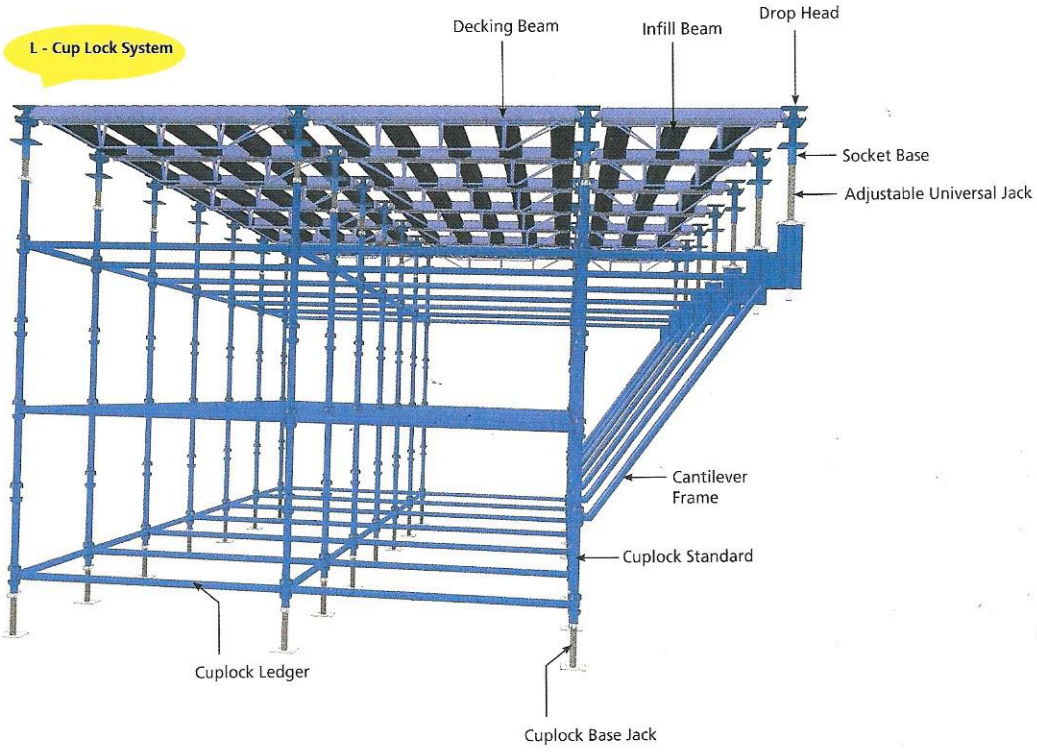

Name & Size Cup Lock Parts

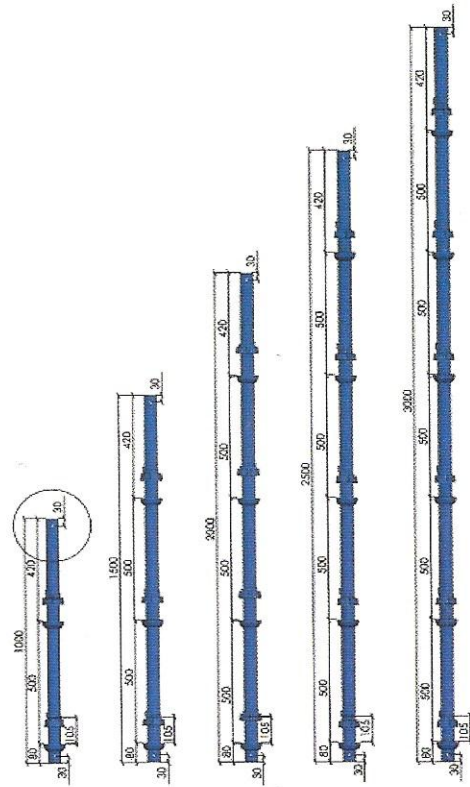

Description	Weight Kg
-------------	-----------

Cuplock Standard Thk. 3.20mm	
cuplock Standard 100 cm	4.90
cuplock Standard 150 cm	7.15
cuplock Standard 200 cm	9.80
cuplock Standard 250 cm	11.90
cuplock Standard 300 cm	14.30

Cuplock Standard Thk. 3.00mm	
cuplock Standard 100 cm	4.59
cuplock Standard 150 cm	6.70
cuplock Standard 200 cm	9.18
cuplock Standard 250 cm	11.15
cuplock Standard 300 cm	13.40

Cuplock Standard Thk. 3.2 mm	
EN-10219 100 cm	5.70
EN-10219 150 cm	8.35
EN-10219 200 cm	10.16
EN-10219 250 cm	13.90
EN-10219 300 cm	16.70

Cuplock Ledgers Thk 3.00mm

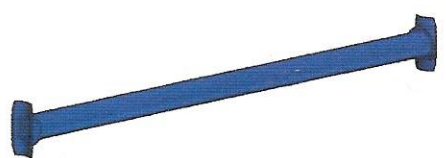

Description	Weight Kg
-------------	-----------

Cuplock Ledger 250cm	8.30
Cuplock Ledger 180cm	6.80
Cuplock Ledger 160cm	6.05
Cuplock Ledger 130cm	5.05
Cuplock Ledger 125cm	4.35
Cuplock Ledger 120cm	4.05
Cuplock Ledger 100cm	3.50
Cuplock Ledger 90cm	3.00
Cuplock Ledger 60cm	2.35

Adjustable Base Jacks Hollow Ø 38/4mm

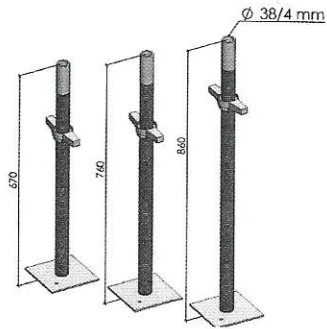

Description	Weight Kg
670mm	3.54
760mm	3.85
860mm	4.20

Description	Weight Kg
-------------	-----------

Adjustable Universal Jacks Hollow Ø 38/4mm

670mm	2.00
760mm	2.25
860mm	2.50

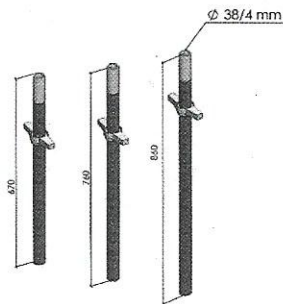

Decking Beams

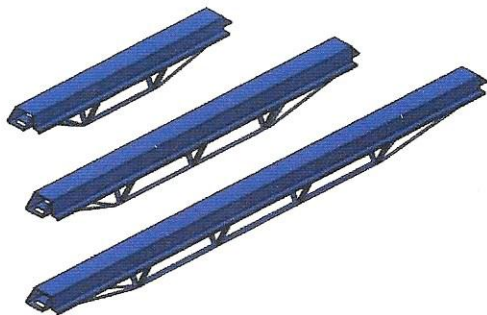

Description	Weight Kg
-------------	-----------

Decking Beam 2500mm	29.00
Decking Beam 1800mm	21.00
Decking Beam 1200mm	14.00

Infill Beams

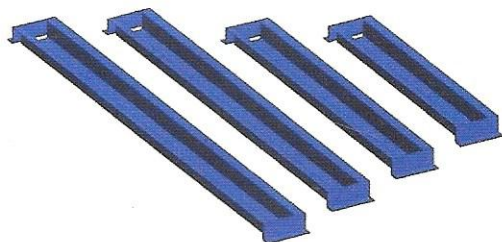

Description	Weight Kg
-------------	-----------

Infill Beam 1800mm	8.75
Infill Beam 1600mm	7.90
Infill Beam 1250mm	5.95
Infill Beam 1000mm	4.95

Drop Head

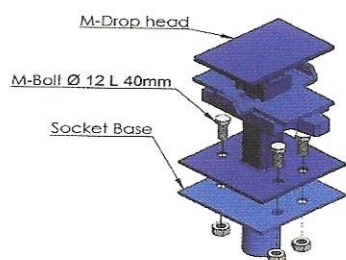

Description	Weight Kg
-------------	-----------

400MM	12.00
-------	-------

Description	Weight Kg
-------------	-----------

500MM	16.00
-------	-------

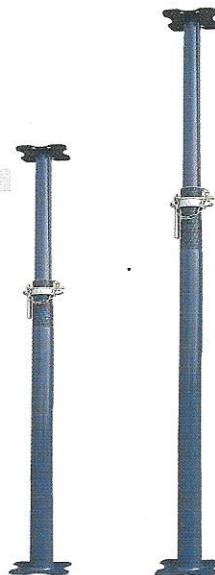

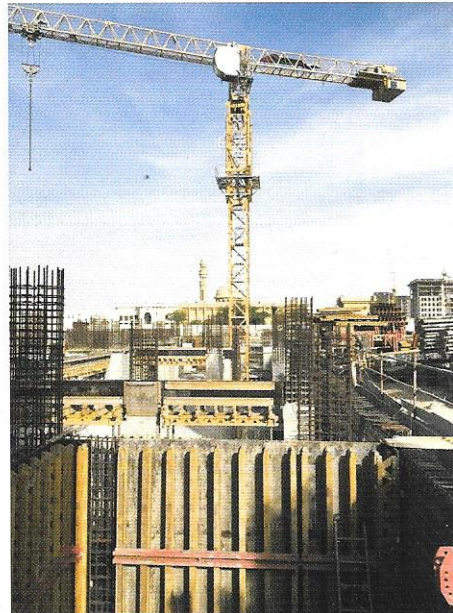
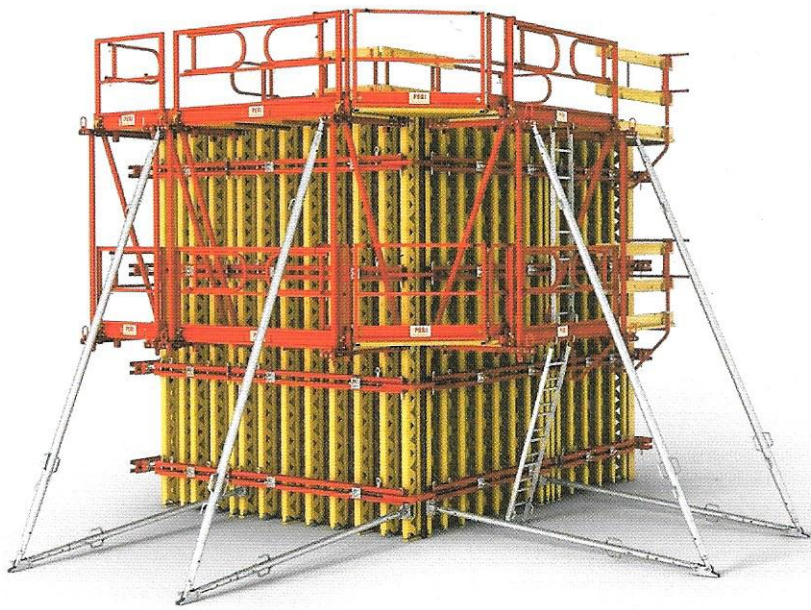

Project No.:
123 Khalifa City

Wall
Casting
Cement



Wall
Hight 390 cm
Concrete Thickness
35 cm

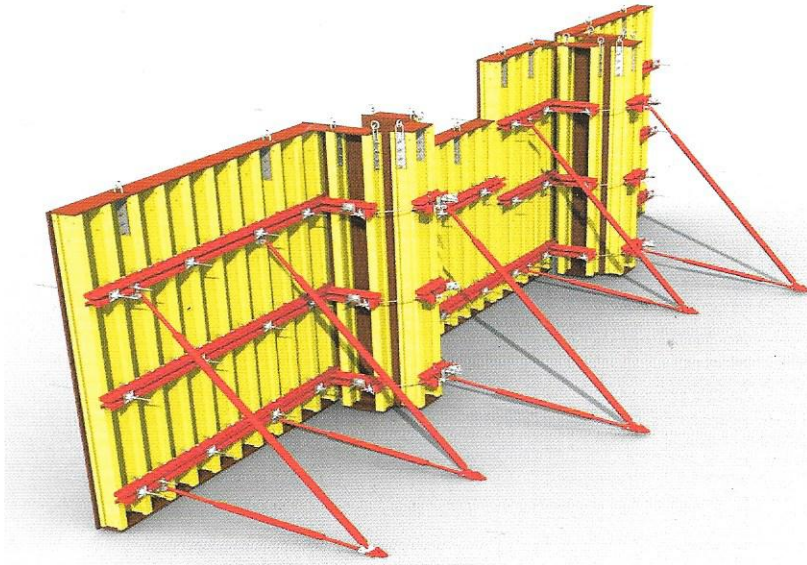

Steel waler 10 for wall

- L 500 mm
- L 750 mm
- L 1000 mm
- L 1500 mm
- L 1750 mm
- L 2000 mm
- L 2400 mm
- L 2750 mm
- L 3000 mm

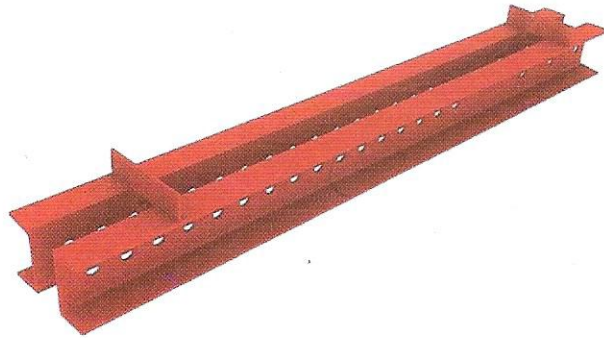

Weight Kg

- 12.54
- 25.96
- 53.77
- 55.12
- 66.00
- 70.98
- 79.64
- 100.03
- 106.48

Components

Push Pull

- Push Pull Prop 100 - 200
- Push Pull Prop 200 - 300
- Push Pull Prop 300 - 400
- Push Pull Prop 400 - 500
- Push Pull Prop 500 - 600
- Push Pull Prop 600 - 700
- Push Pull Prop 800 - 900
- Push Pull Prop 900 - 1000

Weight Kg

- 9.00
- 9.83
- 13.14
- 15.29
- 17.17
- 18.99
- 23.07
- 26.77

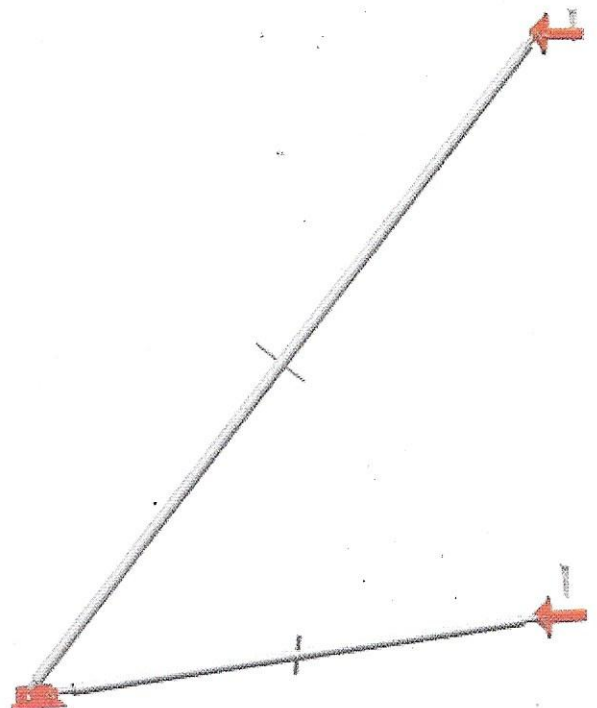
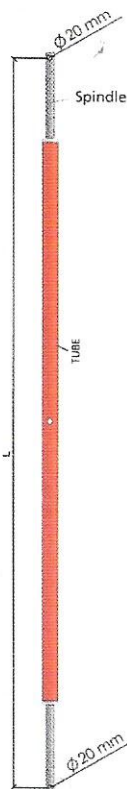

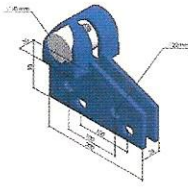

Universal Angel Tie



Counter Plate

120 x 120 x 8 mm
120 x 120 x 6 mm

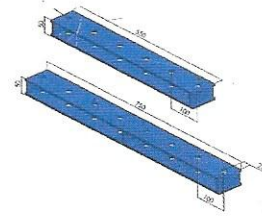

Steel waler splice

Splice 750 mm
Splice 550 mm

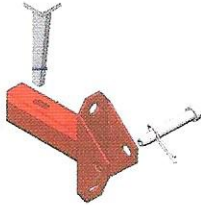

Head Plate

Head plate with widge - Rivet Pin - Spring Clip



Wing Nut

Wing Nut 16 mm

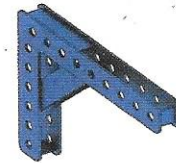

Column Steel waler Connection



Double Base Plate



Washer Nut

Washer Nut Ø 16Mm-100 mm



H20 Beam Clamps

Flang clamp H20

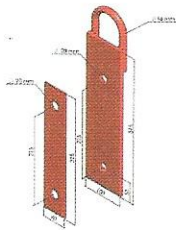

H20 Lifting Eye

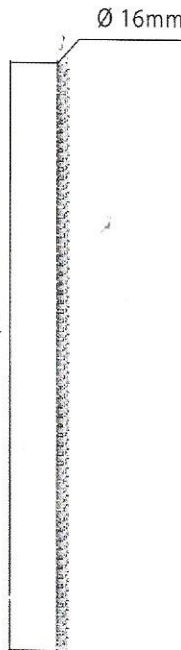

Tie Rod

- Tie rod L= 0.50 mm
- Tie rod L= 1.00 mm
- Tie rod L= 1.50 mm
- Tie rod L= 2.00 mm
- Tie rod L= 2.50 mm
- Tie rod L= 3.00 mm
- Tie rod L= 3.50 mm
- Tie rod L= 4.00 mm
- Tie rod L= 6.00 mm

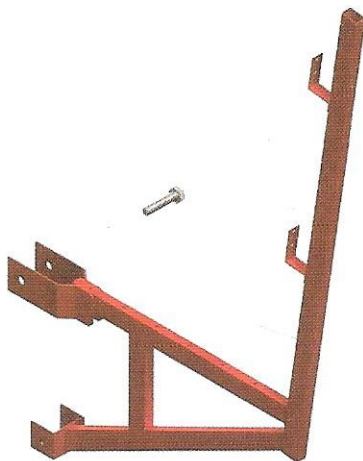

Access Bracket

H20 Access Bracket

Universal Clamp

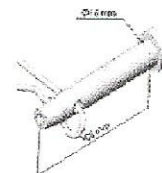

Rivet Pin With Spring Clips

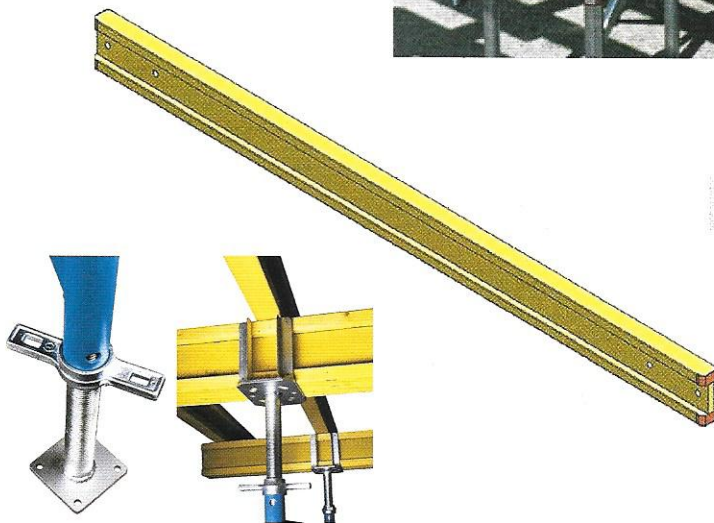

Description	Weight Kg
-------------	-----------

L 1900 mm	8.74
L 2450 mm	11.27
L 2900 mm	13.34
L 3900 mm	17.94
L 4900 mm	22.54
L 5900 mm	27.14



Description	Weight Kg
-------------	-----------

1000 mm	3.2
2000 mm	6.25
3000 mm	9.78
4000 mm	13.04
5000 mm	16.30

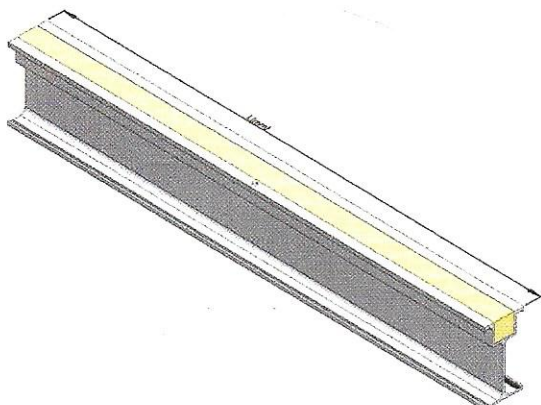

Saadiyat Island Projects No.: 124

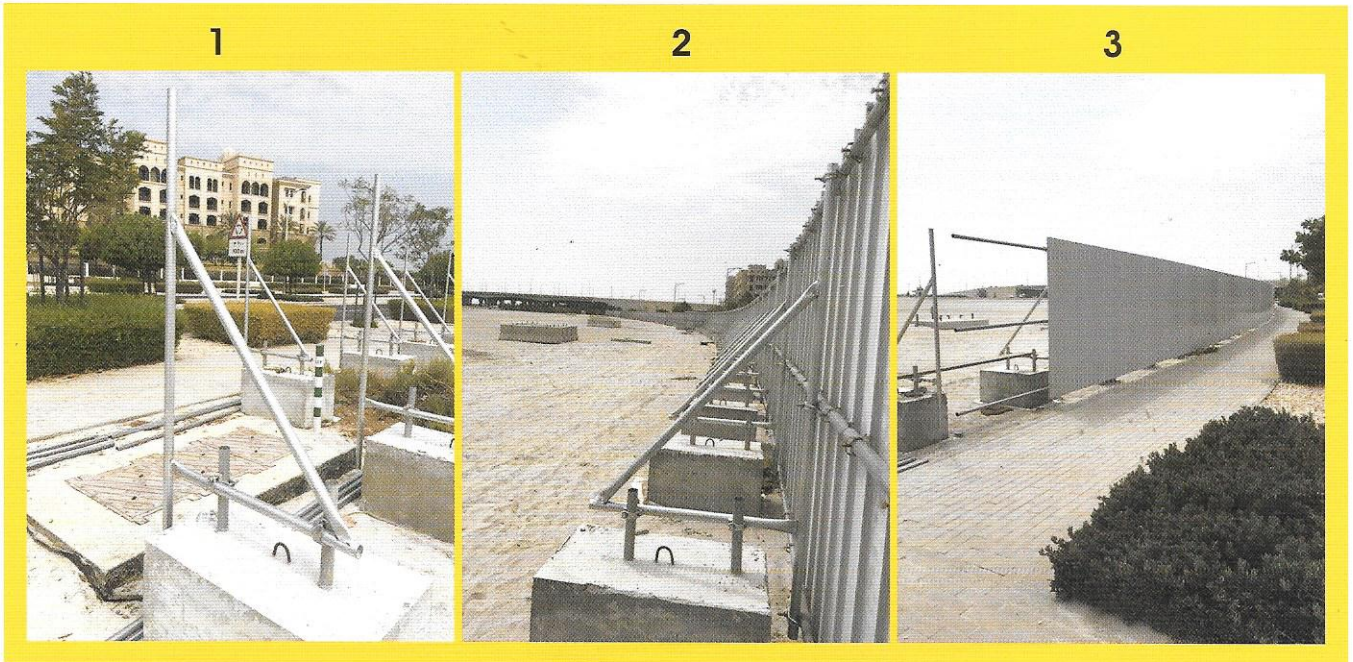

Abu Dhabi City No.: 125

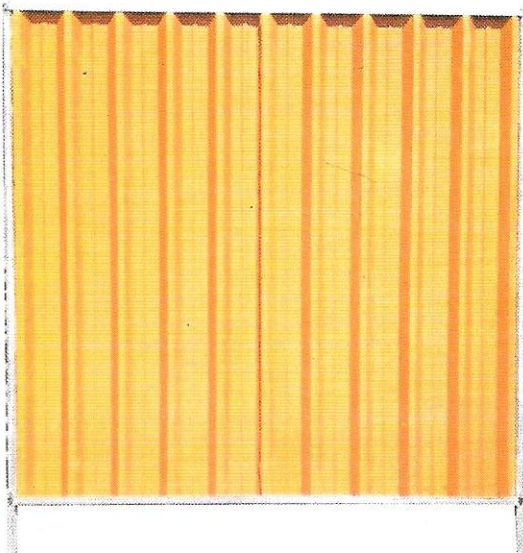

Aluminium Scaffolding

Size: 250 x 150 mtr

New & Rent

Size: 85 x 180 mtr

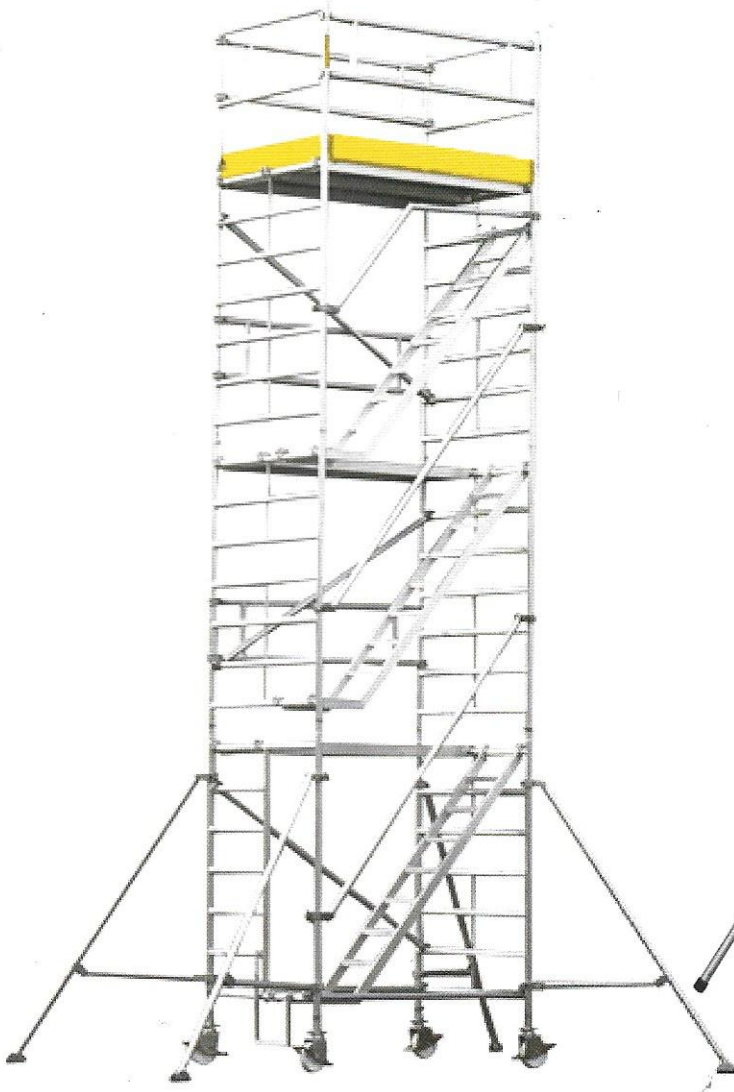

GI Scaffolding
Size 65 x 120 mtr



H Frame System

Size 1mte x 3mte

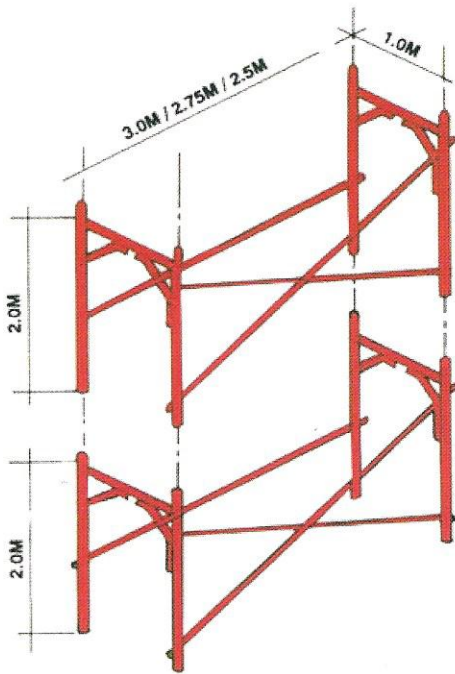
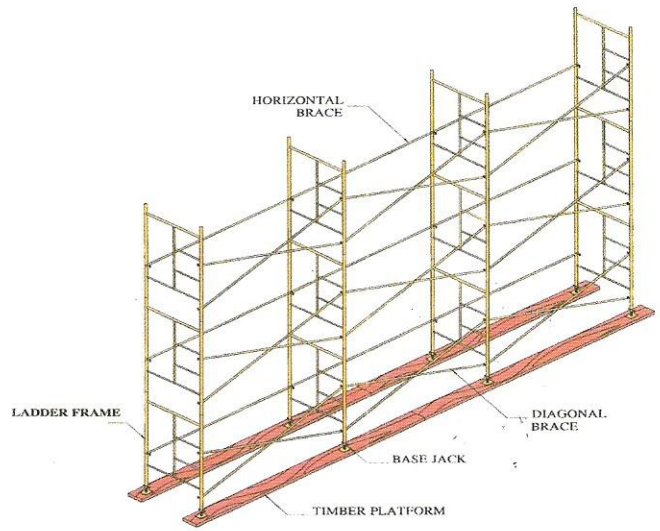

Safety Design

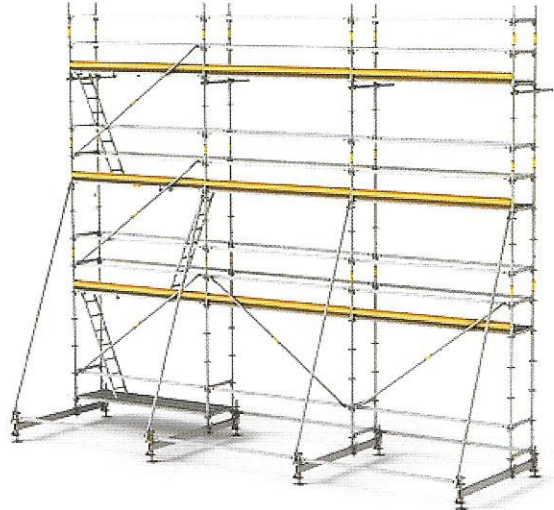

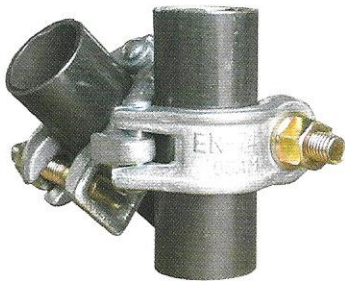

Swivel Coupler
Code NO.: 8200

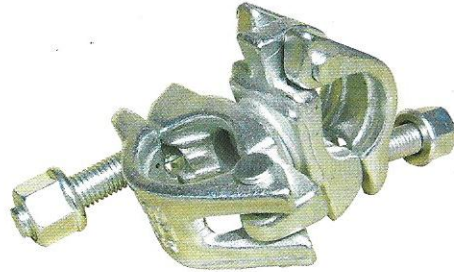

Double Coupler
Code NO.: 8201

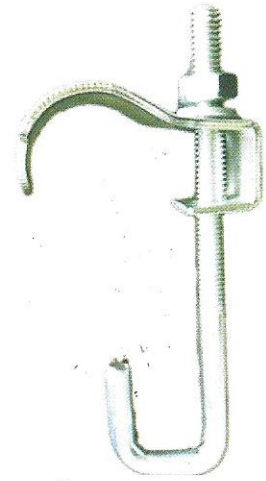

Leader Clamp
Code NO.: 8202

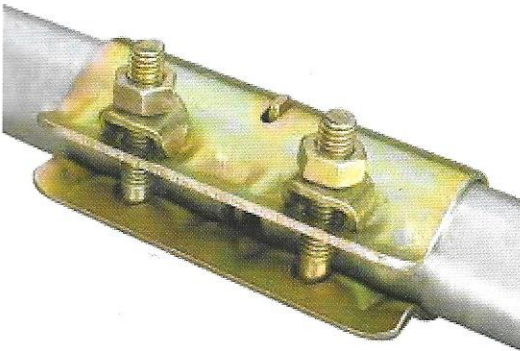

Tube Clamp
Code NO.: 8203



Blank Clamp
Code NO.: 8204

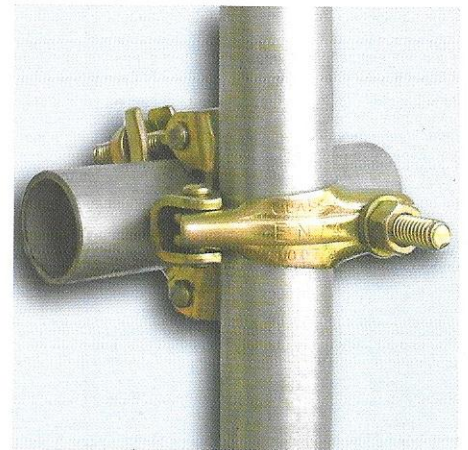

Light Clamp
Code NO.: 8205

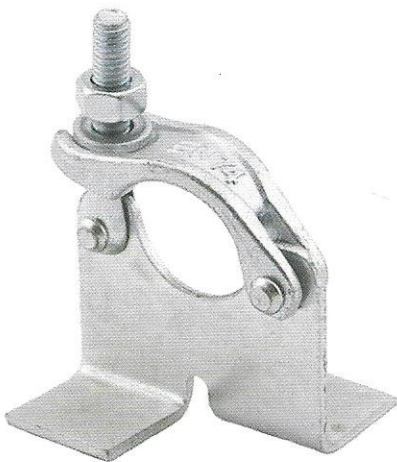

BRC Clamp
Code NO.: 8206

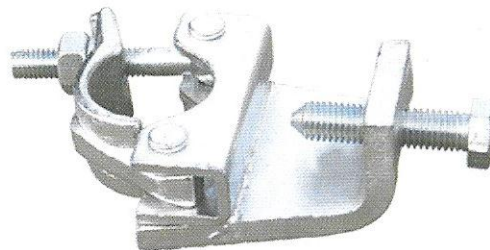

Gravlock Girder Clamp
Code NO.: 8207



Wheels
Code NO.: 8208



CUP LOCK SYSTEM



CUP LOCK & H20



H FRAME SYSTEM



CUP LOCK & ALUMINIUM



WALER STEEL



WALER FOR CULOMS



CAPLECK SLAP



EXSAT SCAFFOLDING



FENCE SYSTEM



DOKA SLAP



GI SCAFFOLDING



ALUMINIUM TOWER

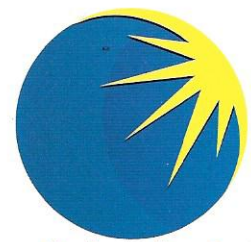

Light
Scaffolding

Tel.: 02-5565232

Mob.: 050 820 0197

Mob.: 050 712 3833

Mob.: 056 818 1805

Mussafah M-11, Abu Dhabi, UAE

E-mail: light.scaffolding@gmail.com

www.lightscaffolding.com