

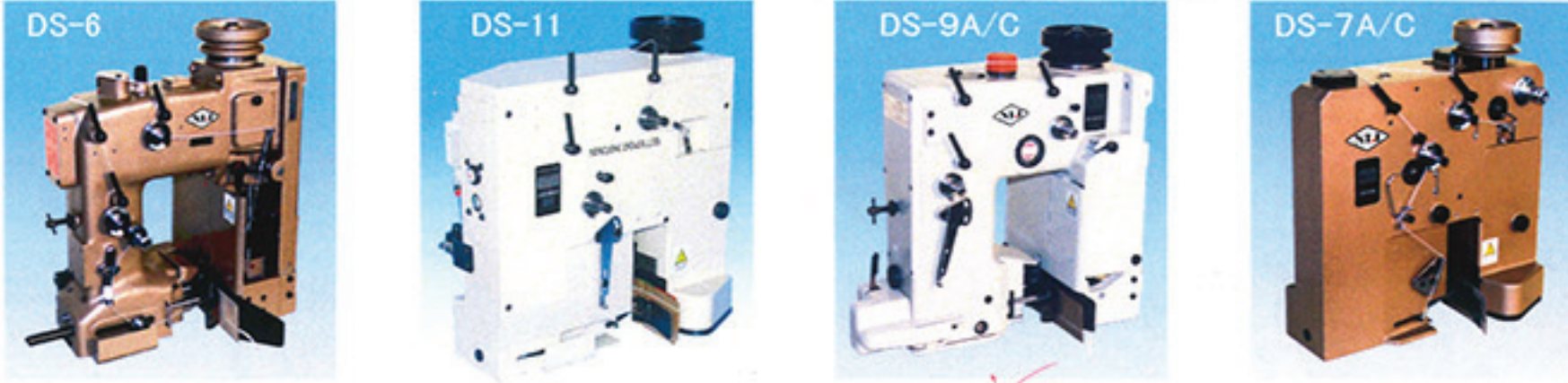

NLI Fujioka Factory has adopted ISO 9001 to be certified its quality control technology for Industrial Sewing Machine and relative products.

BAG CLOSING MACHINE HEAD



BAG SEWING MACHINE HEAD



PORTABLE BAG CLOSER



NEWLONG INDUSTRIAL CO., LTD.

8-14, Shiratori 4-chome, Katsushika-ku, Tokyo 125-0063, Japan

Tokyo Head Office      PHONE +81-3-3603-2276      FAX +81-3-3603-2253  
 Mechanical Design Engineering Dept      PHONE +81-3-3603-2252      FAX +81-3-3602-2694

NLI Group Home Page URL/E-mail

URL <http://nlwww.com/>  
 E-mail [info@nlwww.com](mailto:info@nlwww.com)

GENERAL CATALOG

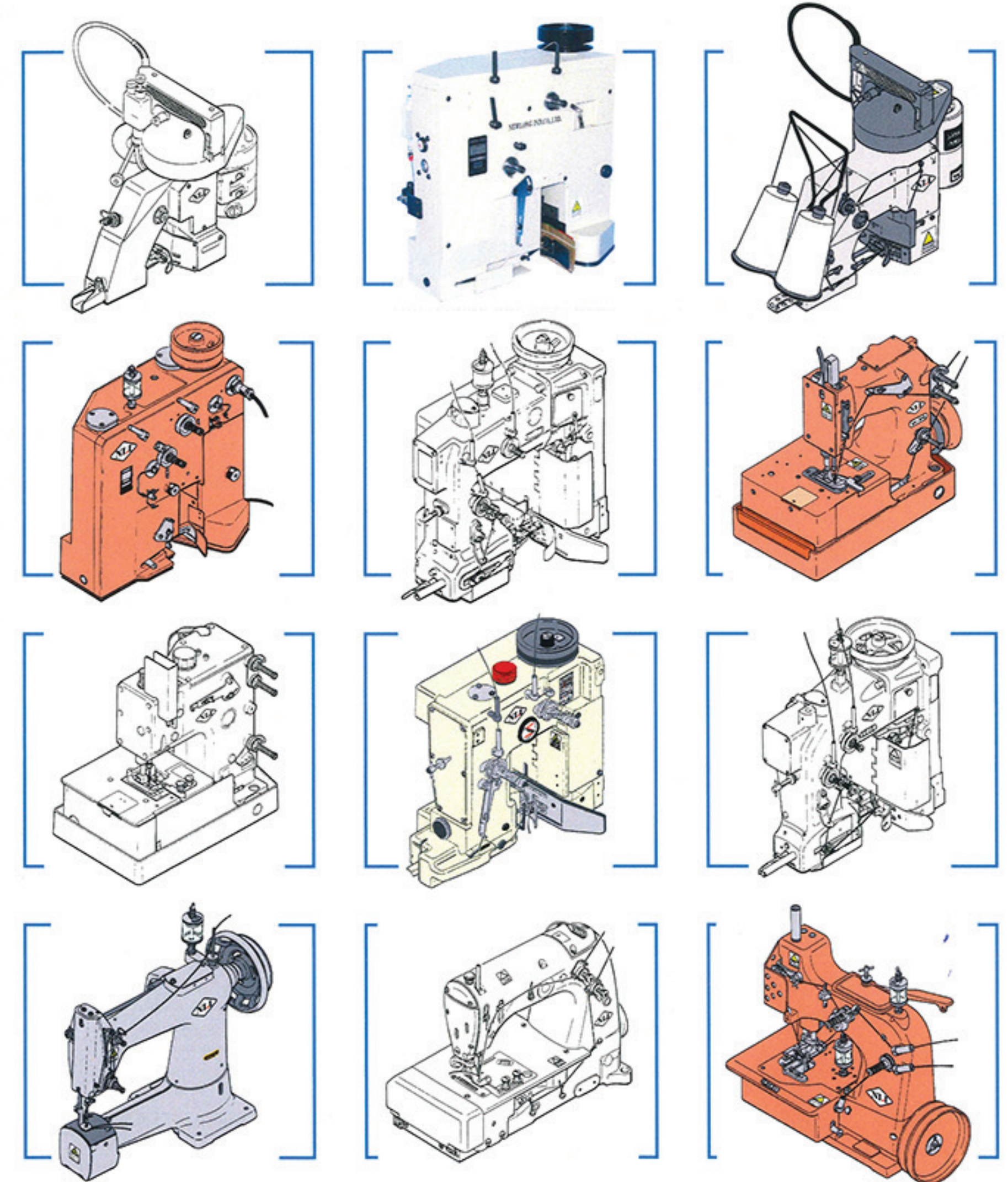





## AUTOMATIC & SEMI-AUTOMATIC BAGGING SYSTEM

### 3CM-P

**AUTOMATIC BAGGING MACHINE**  
High-capacity & wide application.



SPECIFICATIONS		3CM-P
Capacity		MAX 1200 B/H
Products		PP/PE resin pellets, Animal feed, fertilizer, etc.
Filling Weight		20~50Kg / bag
Bag Material		Paper, PP/PE woven cloth, Polyethylene.
Bag Size	Width (mm)	380~520
	Length (mm)	Any 200 range 550~1050

### 3CM-6KH

**AUTOMATIC BAG PLACER**  
High-speed, low cost & minimum space.



SPECIFICATIONS		3CM-6KH
Capacity		MAX 1200 B/H
Products		PP/PE resin pellets, Animal feed, fertilizer, etc.
Filling Weight		10~50Kg/bag
Bag Material		Paper, Woven-laminated paper.
Bag Size (mm)		650~950L×350~470W×114GW

### EFS-22

**AUTOMATIC BAGGING MACHINE** PE gusseted film bag making & filling system.



SPECIFICATIONS		EFS-22
Capacity		MAX 1600B/H
Product name		Resin pellets
Set weight per bag		25Kg
<b>Packing material</b>		
Film thickness		80~200 μ
Film roll		Roll tube with gusset
Outer diameter		MAX φ 1500mm
Inside core		φ 150mm
Empty bag length		700~850mm
Empty bag width		380~460mm
Gusseted depth		35~80mm
Distance between gussets		Standard 260mm
Bag bottom seal		Impulse seal
Bag mouth seal		Impulse seal
Corner seal		Hot plate
Compressed air consumption		1700NL/min
Electrical supply		24KVA

## BAG CLOSING MACHINE / WRAPPING MACHINE

A VARIETY OF MODELS AVAILABLE TO COPE WITH EVERY BAGGING REQUIREMENTS.

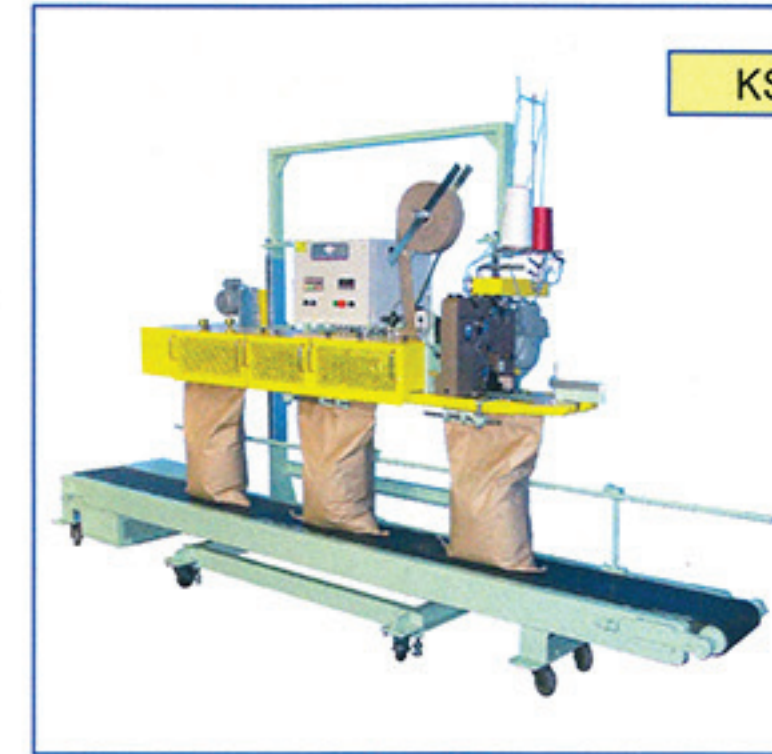

KS-14



KS-23

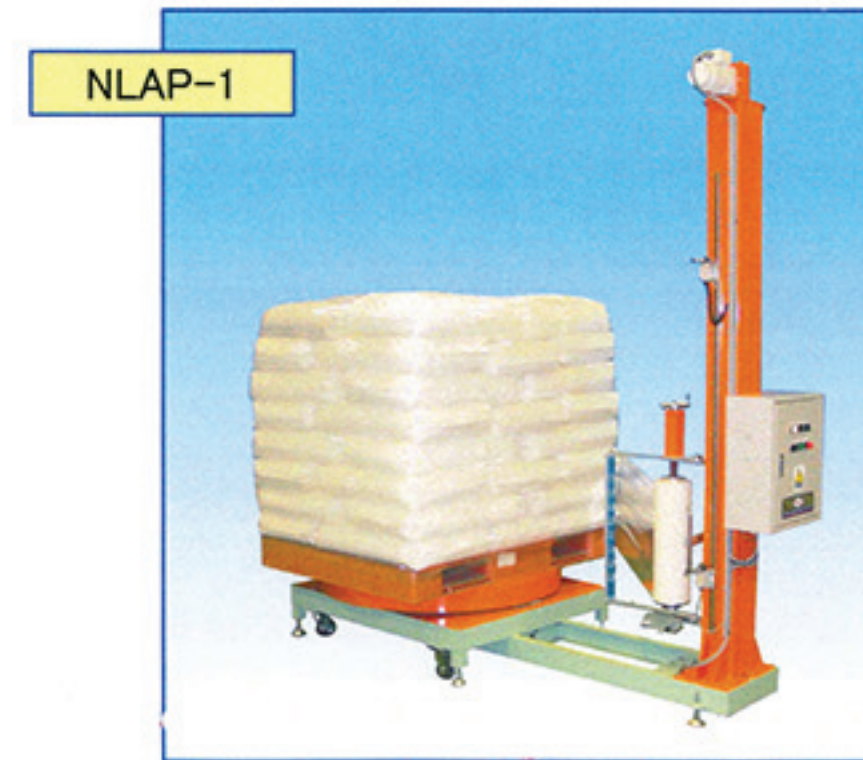

NLAP-1

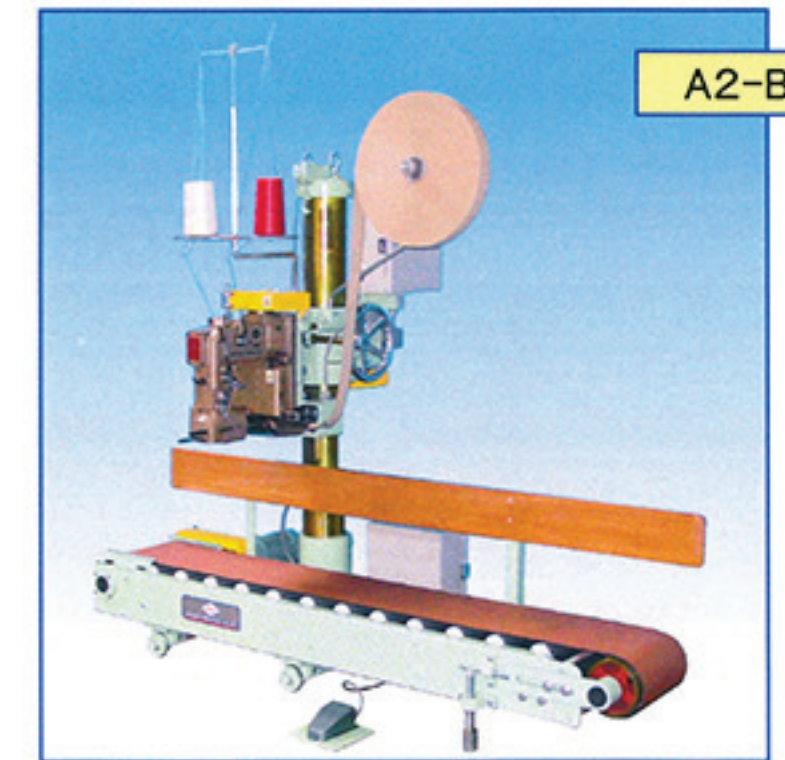

A2-B2L



A1-PB(DS-9C)+CM4900-3

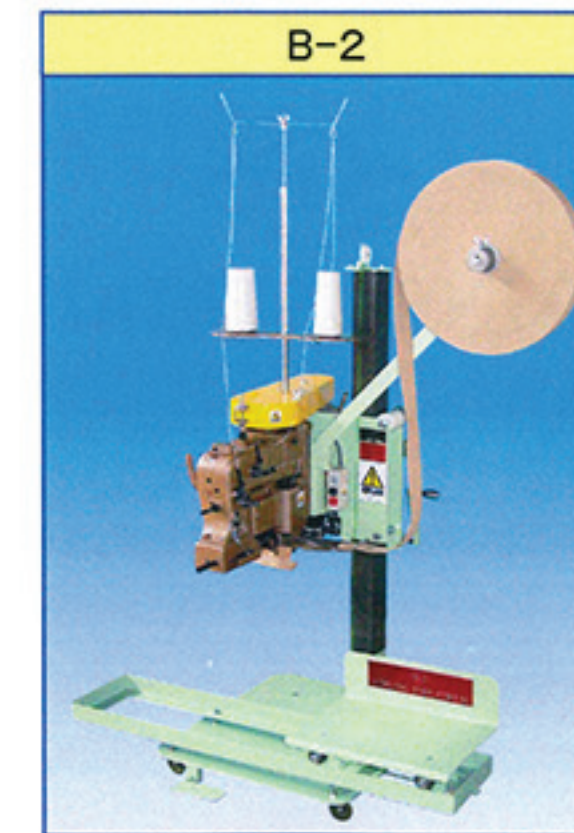

B-2



F-5



## SPECIAL SEWING HEAD

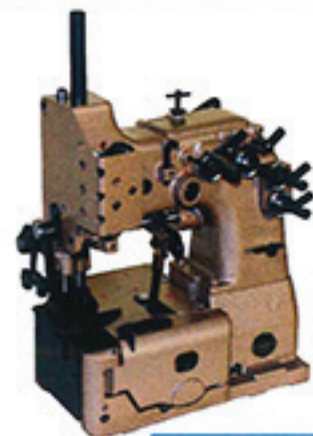

Model	DHR-6
Max. Speed	1400rpm
Seam	Overseaming stitch
Stitch Width	6~13mm
Needle	UY9853G 430
Thread	Polypropylene
Bag Material	Jute · PP
Oiling	by hand · Oiler

Model	HR-2A/HR-2J
Max. Speed	1800rpm
Seam	Overseaming stitch
Stitch Width	6.5~15mm
Needle	UO1970 400
Thread	Cotton · Jute
Bag Material	Jute · PP
Oiling	by hand · Oiler

Model	DR-7UW
Max. Speed	1400rpm
Seam	Double thread chain stitch (Type 401)
Stitch Width	7~12mm
Needle	UO-H34 #29
Thread	Polypropylene
Bag Material	Container bags
Oiling	by hand · Oiler

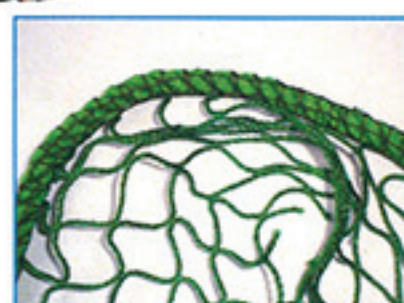
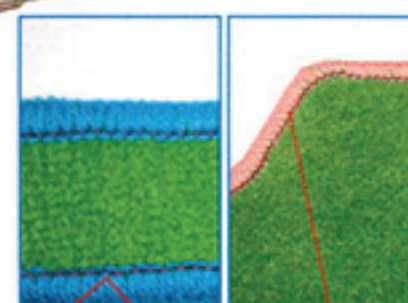
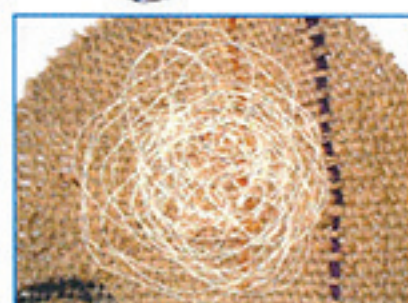

Model	DD-5
Max. Speed	1500rpm
Seam	Lock stitch
Stitch Width	Free feed
Needle	216×7 280
Thread	Cotton
Bag Material	Container bags Jute (jute bag repair)
Oiling	by hand · Oiler

Model	HR-4A	HR-4B	HR-4C
Max. Speed	1800rpm		
Seam	Decoration sewing	Volume sewing	Curve sewing
Stitch Width	3.5~6mm		
Needle	SG-H28 #26	DR-G94 #27	
Thread	Wool	Synthetic	
Application	Rug · Carpet	The carpet for cars	
Oiling	by hand · Oiler		

Model	HR-4N
Max. Speed	800rpm
Seam	Overseaming stitch (cording)
Stitch Width	6.5~15mm
Needle	DR-H32 #32
Thread	Synthetic
Application	Fishing net · Sport net
Oiling	by hand · Oiler

## NEWLONG INDUSTRIAL CO., LTD.

8-14, Shiratori 4-chome, Katsushika-ku, Tokyo 125-0063, Japan

Tokyo Head Office

Mechanical Design Engineering Dept

PHONE +81-3-3603-2276

PHONE +81-3-3603-2252

FAX +81-3-3603-2253

FAX +81-3-3602-2694

URL <http://nlwww.com/>  
E-mail [info@nlwww.com](mailto:info@nlwww.com)



NLI Fujioka Factory has adopted ISO 9001 to be certified its quality control technology for Industrial Sewing Machine and relative products.

# GENERAL CATALOG SEWING MACHINE

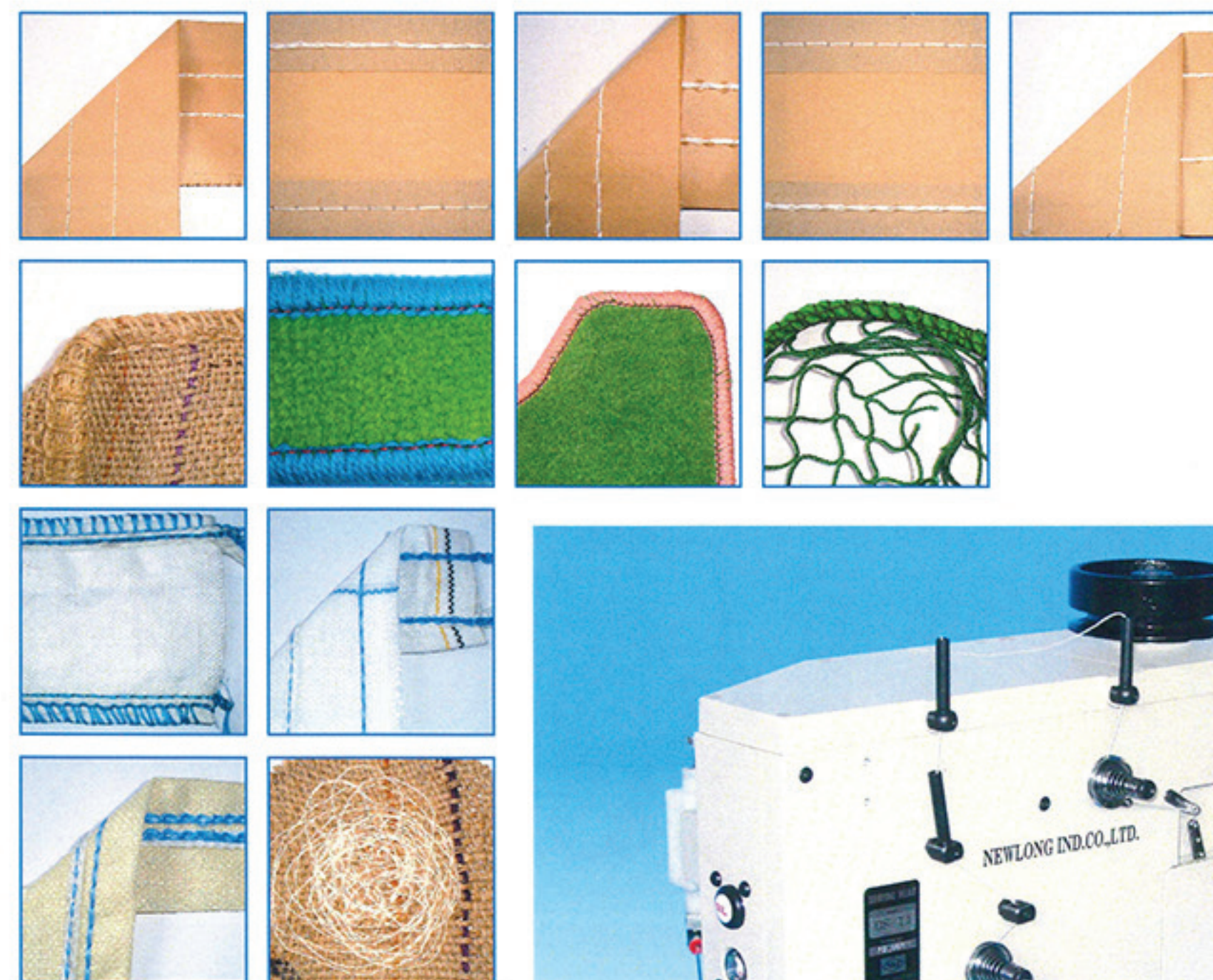

NEWLONG INDUSTRIAL CO., LTD.

MM-002



## BAG CLOSING SEWING HEAD

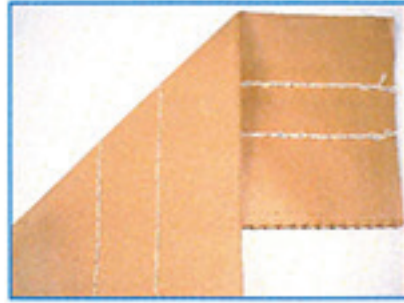
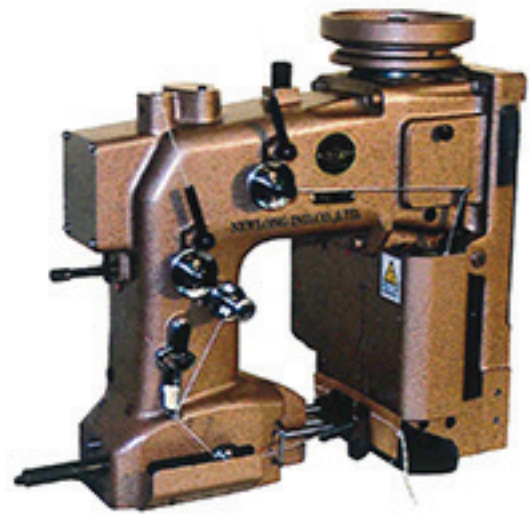

Model	DS-2 II
Max. Speed	1400rpm
Seam	Duple thread chain stitch (Type 401)
Stitch Width	7~12mm
Needle	DR×2 #25
Thread	20/6 · 20/9
Bag Material	Paper · PP · Cotton · Jute
Oiling	by hand · Oiler

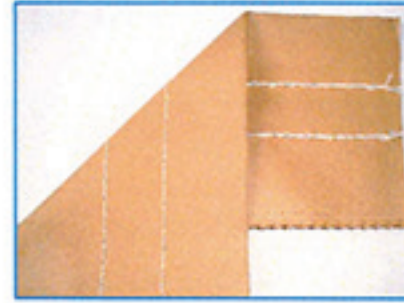

Model	DS-5 II
Max. Speed	800rpm
Seam	Duple thread chain stitch (Type 401)
Stitch Width	7~12mm
Needle	DR×2 #26
Thread	20/6 · 20/9
Bag Material	Paper · PP · Jute
Oiling	by hand

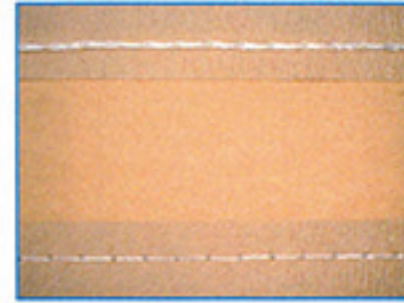
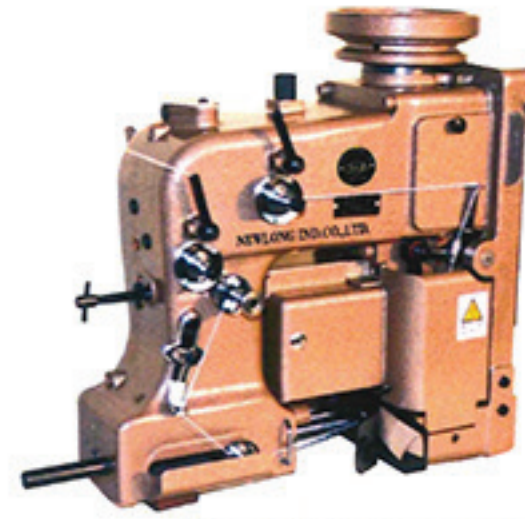

Model	DS-C
Max. Speed	1400rpm
Seam	Duple thread chain stitch (Type 401)
Stitch Width	7~12mm
Needle	DR×2 #25
Thread	20/6 · 20/9
Bag Material	Paper
Oiling	by hand · Oiler

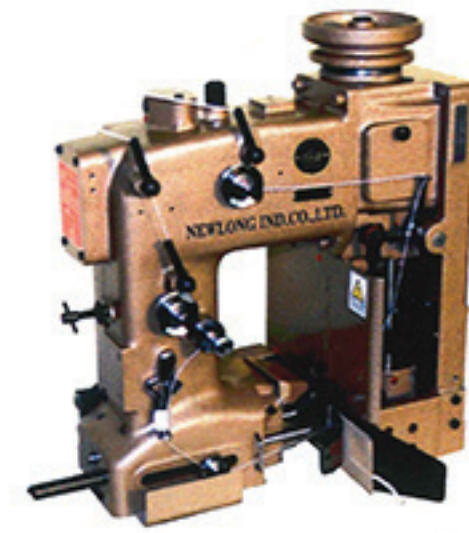

Model	DS-6AC	DS-6HS/DS-6W
Max. Speed	1400rpm	1800rpm
Seam	Duple thread chain stitch (Type 401)	
Stitch Width	7~10.5mm	
Needle	DR×2 #25	
Thread	20/6 · 20/9	
Bag Material	Paper · PP	
Oiling	by hand · Oiler	

## BAG MAKING SEWING HEAD

\* A photograph is DN-2HS.  
DN-2LHS is a symmetrical  
type of photograph.

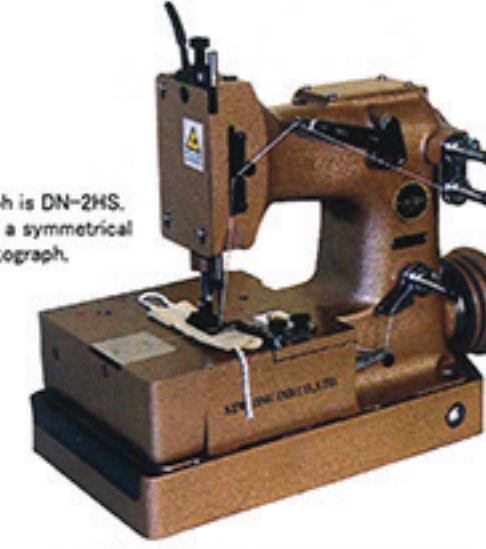

Model	DN-2HS	DN-2LHS	DN-2W
Max. Speed	3000rpm		
Seam	Duple thread chain stitch (Type 401)		
Stitch Width	7~12mm	7~11mm	
Needle	DR×2 #25	UY143GS 200	
Thread	20/6 · 20/9		
Bag Material	Paper · PP		
Oiling	Automatic		

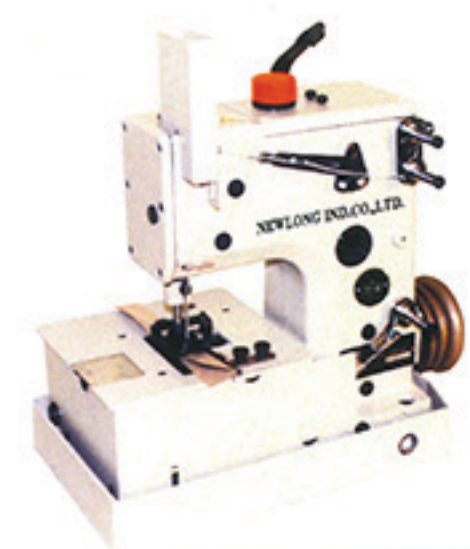

Model	DN-5U
Max. Speed	2800rpm
Seam	Duple thread chain stitch (Type 401)
Stitch Width	7~12mm
Needle	DR×2 #25
Thread	20/6 · 20/9
Bag Material	Paper · PP
Oiling	Automatic

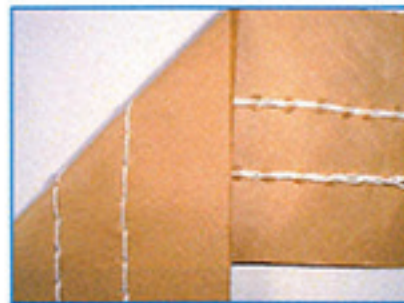

Model	DS-7A/DS-7C
Max. Speed	1600rpm
Seam	Duple thread chain stitch (Type 401)
Stitch Width	7.7mm (fixed)
Needle	DN-H29 #26
Thread	20/6 · 20/9
Bag Material	Paper · PP
Oiling	by hand · Oiler

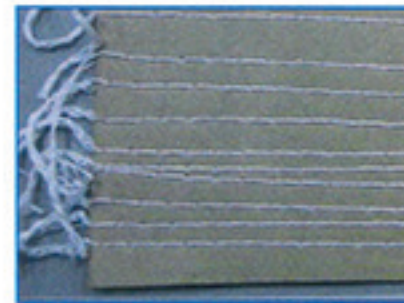

Model	DS-11
Max. Speed	2000rpm
Seam	Duple thread chain stitch (Type 401)
Stitch Width	10.2mm (fixed)
Needle	DN-H29 #26
Thread	20/6 · 20/9
Bag Material	Paper · PP
Oiling	Automatic · Oil pump · Oil bath

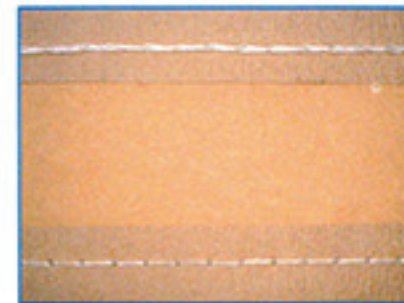

Model	DS-9A/9C, DS-9AW/9CW
Max. Speed	2500rpm
Seam	Duple thread chain stitch (Type 401)
Stitch Width	7~10.5mm
Needle	DR-H30 #26
Thread	20/6 · 20/9
Bag Material	Paper · PP
Oiling	Oil bath



Model	DKN-1/DKN-1BP
Max. Speed	3800rpm
Seam	Duple thread chain stitch (Type 401)
Stitch Width	3.6~8.5mm
Needle	UY143GS 200
Thread	20/6
Bag Material	Paper · PP
Oiling	Automatic



Model	DKN-3/3BP	DKN-3W
Max. Speed	5000rpm	4000rpm
Seam	Duple thread chain stitch (Type 401)	
Stitch Width	5~9.5mm	
Needle	UY144GS 200	
Thread	20/6	
Bag Material	PP	
Oiling	Automatic	

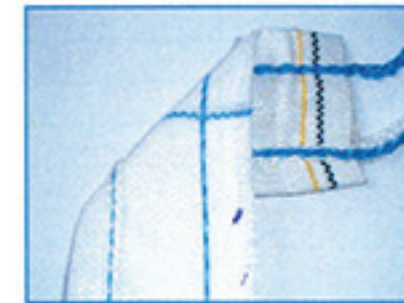

Model	DR-3A
Max. Speed	1800rpm
Seam	Duple thread chain stitch (Type 401)
Stitch Width	6.5~15mm
Needle	UO-H33 #27
Thread	Cotton · Synthetic · Jute
Bag Material	Jute · Container bags
Oiling	by hand · Oiler