



Since 1957



Deluxe
Embosser

Nature is the future



Shiny Takes Action for the Environment

In 2014, Shiny signed a memorandum with the Taiwanese Government on a solar power generating project. Shiny has cooperated with the Taiwanese Government, setting up solar panels on all of the roofs at its three factory sites to produce green energy.

According to Taiwan Power Company (Taipower) and the Industrial Technology Research Institute (ITRI), the project is estimated to produce 757,000 kWh from solar power per year, achieving 386,000 kg of CO₂ savings. In other words, Shiny creates 386,000 kg of carbon credit through its contribution every year.

In addition, Shiny also emphasizes its devotion to an eco-friendly environment by planting nearly 400 trees and plants on its factory sites. Shiny has done all of this because it believes in operating without harming Mother Nature.



Shiny has been awarded the ISO 14001: 2004 Standard



2017 Index

Printer Line S-814 / S-851~S-855 Self-Inking Stamp	1
Printer Line Self-Inking Stamp / Self-Inking Dater / Self-Inking Number	3
Elite Stamp Self-Inking Stamp / Pre-Inked Stamp	12
Handy Stamp Self-Inking Stamp / Pre-Inked Stamp	13
NTbac Line / Heavy Metal Self-Inking Stamp / Pre-Inking Dater	15
ECO Line Self-Inking Stamp / Self-Inking Dater / Die-Plate Date Stamp	21
Essential Line / Heavy Duty Self-Inking Stamp / Self-Inking Dater / Self-Inking Number	23
DUO Hand Stamp	27
Embossing Seal Seal	31
Textile Labeling Kit Self-Inking Stamp / Self-Inking Printing Kit	35
OA Stamp Stock Stamp	37
D-I-Y Set Self-Inking Printing Kit / Extra Rubber Type Plate	44
Die-Plate Dater Die-Plate Date Stamp / Time & Date Stamp	53
Date Stamp / Number Stamp / Die-Plate Dater Date Stamp / Number Stamp / Flateband Die-Plate Dater / Dial-a-Phrase Stamp	57
Stamp Pad	60
Ink	62
Laser Rubber Sheet	65
Replacement Ink Pad	67
Personal Seal Wax Seal Stamp	69
Flash Stamp Premier Line / Lite / Eminent Line / Eminent Kit	72

Enrich your desktop

Printer Line

Handle Color:



1. White



2. Black



3. Blue



4. Red



5. Lime green



S-814

S-814	
SIZE OF IMPRINT	8 x 14 mm
SPARE PAD	S-814-7 
PACKING	
COLOR	1~5
OPTION: Bottom Cover is included in S-814	



S-851

S-851	
SIZE OF IMPRINT	10 x 26 mm
SPARE PAD	S-851-7 
PACKING	
COLOR	1~5
OPTION: S-851-8 Bottom Cover 	



S-852	
SIZE OF IMPRINT	14 x 38 mm
SPARE PAD	S-852-7 
PACKING	
COLOR	1~5
OPTION:	S-852-8 Bottom Cover 



S-853	
SIZE OF IMPRINT	18 x 47 mm
SPARE PAD	S-853-7 
PACKING	
COLOR	1~5
OPTION:	S-853-8 Bottom Cover 



S-854	
SIZE OF IMPRINT	22 x 58 mm
SPARE PAD	S-854-7 
PACKING	
COLOR	1~5
OPTION:	S-854-8 Bottom Cover 



S-855	
SIZE OF IMPRINT	25 x 70 mm
SPARE PAD	S-855-7 
PACKING	
COLOR	1~5
OPTION:	S-855-8 Bottom Cover 



Identity Series Trim Plate



TP-001
black background white line



TP-002
black background yellow line



TP-003
black background lime green line



TP-004
black background fuchsia line







TP-005
black background red line



Printer Line

Precision structure promises supreme quality impressions, and smooth operation guarantees quieter movement.

	SIZE				SIZE			PACKING
S-841	10 x 26 mm	S1821-7	S1821-8	S-844	22 x 58 mm	S1824-7	S1824-8	
S-841L	10 x 30 mm	S821L-7	S821L-8	S-845	25 x 70 mm	S1825-7	S1825-8	
S-842	14 x 38 mm	S1822-7	S1822-8	S-846	27 x 65 mm	S-846-7		
S-843	18 x 47 mm	S1823-7	S1823-8					

COLOR: 1~11

- 1.White 2.Black 3.Blue 4.Yellow 5.Red 6.Ruby 7.Amethyst 8.Peridot 9.Topaz
10.Aquamarine 11.Smoke Gray



Imprint size



S-841



S-843



S-845



S-841L



S-844



S-842



S-846





① Black ② Blue ③ Yellow ④ Red



S-835



S-835 / S-835D	
SIZE OF IMPRINT	20 x 30 mm
SPARE PAD	S-835-7 
PACKING	
COLOR	1~4



S-826



S-826 / S-826D	
SIZE OF IMPRINT	24 x 41 mm
SPARE PAD	S-400-7B 
SPARE PAD	S-400-7C 
PACKING	
COLOR	1~4



S-836



S-836 / S-836D	
SIZE OF IMPRINT	30 x 45 mm
SPARE PAD	S-836-7 
SPARE PAD	S-836D-7 
PACKING	
COLOR	1~4



S-827



S-827 / S-827D	
SIZE OF IMPRINT	30 x 50 mm
SPARE PAD	S-827-7 
SPARE PAD	S-827D-7 
PACKING	
COLOR	1~4



S-837



S-837 / S-837D	
SIZE OF IMPRINT	40 x 50 mm
SPARE PAD	S-837-7 
SPARE PAD	S-837D-7 
PACKING	
COLOR	1~4

S-828



S-828 / S-828D	
SIZE OF IMPRINT	33 x 56 mm
SPARE PAD	S-828-7
SPARE PAD	S-828D-7
PACKING	
COLOR	1~4

S-829



S-829 / S-829D	
SIZE OF IMPRINT	40 x 64 mm
SPARE PAD	S-829-7
SPARE PAD	S-829D-7
PACKING	
COLOR	1~4

S-834



S-834 / S-834D	
SIZE OF IMPRINT	30 x 65 mm
SPARE PAD	S-834-7
SPARE PAD	S-834D-7
PACKING	
COLOR	1~4

S-830



S-830 / S-830D	
SIZE OF IMPRINT	38 x 75 mm
SPARE PAD	S-830-7
SPARE PAD	S-830D-7
PACKING	
COLOR	1~4

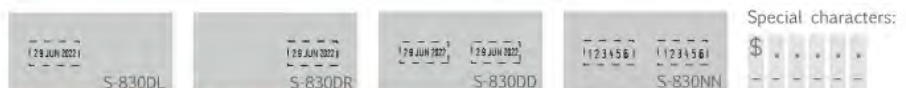

(Also available with number bands.)



COPIA
S-820

CHECKED
S-815

PASS Q.C. MAIL
S-515 S-510

PASS!
S-520



	SIZE		COLOR	PACKING
S-820	6x12 mm	S-820-7	1~9	
S-815	8x15 mm	S-815-7	1~4	
S-510	12x12 mm	S-510-7	1~4	
S-515	15x15 mm	S-515-7	1~4	
S-520	20x20 mm	S-520-7	1~4	

Bottom cover is included in these 5 models.



S-524
www.bertram.com
22 JUN '22
S-524D

S-524 / S-524D	
SIZE OF IMPRINT	24 x 24 mm
SPARE PAD	S-524-7
PACKING	
COLOR	1~4



S-530
SHANGHAI TOY EXPO
29 JUN 2022
S-530D

S-530 / S-530D	
SIZE OF IMPRINT	32 x 32 mm
SPARE PAD	S-530-7
PACKING	
COLOR	1~4



S-538
Holiday Express
29 JUN 2022
S-538D

S-538 / S-538D	
SIZE OF IMPRINT	38 x 38 mm
SPARE PAD	S-538-7
SPARE PAD	S-538D-7
PACKING	
COLOR	1~4
OPTION:	S-538-8 Bottom Cover



S-542
COMM FOR
29 JUN 2022
S-542D

S-542 / S-542D	
SIZE OF IMPRINT	42 x 42 mm
SPARE PAD	S-542-7
SPARE PAD	S-542D-7
PACKING	
COLOR	1~4
OPTION:	S-542-8 Bottom Cover



S-308

S-308	
SIZE OF IMPRINT	10 x 45 mm
SPARE PAD	S-308-7
PACKING	
COLOR	1-4



S-310

S-310	
SIZE OF IMPRINT	13 x 54 mm
SPARE PAD	S-311-7
PACKING	
COLOR	1-4

S-310A Die Plate: Max. 5 x 49 mm



29 JUN 2022 - 29 JUN 2022

S-310D

P A I D F A X E D R E V I S E D
 E - M A I L E D R E C E I V E D S H I P P E D
 U R G E N T ! A P P R O V E D C H E C K E D
 C A N C E L L E D O V E R D U E C O M P L E T E D

S-310B



29 JUN 2022 1 2 3 4 5 6 7

Special characters:



P A I D 29 JUN 2022



S-310C



1 2 3 4 5 6 7 8 9 0 1 2 3

Special characters:



S-310A / S-310B S-310C / S-310D	
SPARE PAD	S-311-7
SPARE PAD	S-311-7A
PACKING	
COLOR	1-4

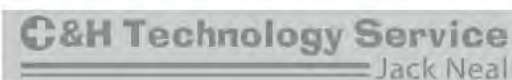

S-831

S-831	
SIZE OF IMPRINT	10 x 70 mm
SPARE PAD	S-831-7
PACKING	
COLOR	1-4



S-832

S-832	
SIZE OF IMPRINT	15 x 75 mm
SPARE PAD	S-832-7
PACKING	
COLOR	1-4



S-833

S-833	
SIZE OF IMPRINT	25 x 82 mm
SPARE PAD	S-833-7
PACKING	
COLOR	1-4



TRI-45

22 JUN '22

TRI-45D

TRI-45 / TRI-45D	
SIZE OF IMPRINT	45 x 45 x 45 mm
SPARE PAD	TRI-45-7
PACKING	
COLOR	1-4



O-3045

29 JUN 2022

O-3045D

O-3045 / O-3045D	
SIZE OF IMPRINT	30 x 45 mm
SPARE PAD	O-3045-7
SPARE PAD	O-3045D-7
PACKING	
COLOR	1-4
OPTION:	O-3045-8 Bottom Cover



O-3555

29 JUN 2022

O-3555D

O-3555 / O-3555D	
SIZE OF IMPRINT	35 x 55 mm
SPARE PAD	O-3555-7
SPARE PAD	O-3555D-7
PACKING	
COLOR	1-4



R-512



R-517



R-517D



R-520

	SIZE		COLOR	PACKING
R-512	Ø 12 mm	R-512-7	1~9	
R-517	Ø 17 mm	R-517-7	1~4	
R-517D	Ø 17 mm	R-517D-7	1~4	
R-520	Ø 20 mm	R-520-7	1~4	

Bottom cover is included in R-512 and R-517D.



R-512 1.Black 2.Blue 3.Yellow 4.Red 5.Ruby 6.Amethyst 7.Peridot 8.Topaz 9.Aquamarine

OPTION: R-520-8 Bottom Cover for R-520



Bottom Cover is included in R-524D



R-524



R-524D

R-524 / R-524D	
SIZE OF IMPRINT	Ø 24 mm
SPARE PAD	R-524-7
PACKING	
COLOR	1~4
OPTION:	R-524-8 Bottom Cover for R-524



R-532



R-532D

R-532 / R-532D	
SIZE OF IMPRINT	Ø 32 mm
SPARE PAD	R-532-7
SPARE PAD	R-532D-7
PACKING	
COLOR	1~4
OPTION:	R-532-8 Bottom Cover



R-538



R-538D

R-538 / R-538D	
SIZE OF IMPRINT	Ø 38 mm
SPARE PAD	R-538-7
SPARE PAD	R-538D-7
PACKING	
COLOR	1~4
OPTION:	R-538-8 Bottom Cover



① Black ② Blue ③ Yellow ④ Red



R-542 / R-542D	
SIZE OF IMPRINT	∅ 42 mm
SPARE PAD	R-542-7
SPARE PAD	R-542D-7
PACKING	
COLOR	1~4
OPTION:	R-542-8 Bottom Cover



R-546 / R-546D	
SIZE OF IMPRINT	∅ 46 mm
SPARE PAD	R-546-7
SPARE PAD	R-546D-7
PACKING	
COLOR	1~4
OPTION:	R-546-8 Bottom Cover



R-552 / R-552D	
SIZE OF IMPRINT	∅ 52 mm
SPARE PAD	R-552-7
SPARE PAD	R-552D-7
PACKING	
COLOR	1~4
OPTION:	R-552-8 Bottom Cover



R-542D-T12 / R-542D-T24	
SIZE OF IMPRINT	∅ 41 mm
SPARE PAD	R-542D-7
PACKING	
COLOR	1~4
OPTION:	R-542-8 Bottom Cover

Note: The die thickness of the R-542D-T12 / R-542D-T24 stamp must be 2.4~2.5mm.

S-300 +
 29 JUN 2022



S-302D +
 29 JUN 2022



4 in 1 Mini Dater S-303 +
 PAID
 29 JUN 2022

S-304 +
 AIR MAIL CHECKED
 APPROVED FILE COPY
 CANCELLED FIRST CLASS
 CONFIDENTIAL CREDIT
 CONFIRMATION OVERDUE
 COPY URGENT!

S-309 +
 1 2 3 4 5 6
 Special characters:
 No.
 \$



S-300 / S-303 / S-302D	
S-304 / S-309 Mini Dater	
SPARE PAD	S-300-7
SPARE PAD	S-303-7
PACKING	
COLOR	1~4

S-400 +
 29 JUN 2022



S-409 +
 1 2 3 4 5 6

Special characters:
 No. . , . %
 \$ - X @ % %

S-401 +
 PAID
 29 JUN 2022



BY: _____

S-414 +
 AIR MAIL CHECKED
 APPROVED FILE COPY
 CANCELLED FIRST CLASS
 CONFIDENTIAL CREDIT
 CONFIRMATION OVERDUE
 COPY URGENT!

S-449 +
 1 2 3 4 5 6 7 8 9

Special characters:
 / / / / / / / / / /

S-402 RECEIVED 29 JUN 2022 BY: _____
 S-403 FAXED 29 JUN 2022 BY: _____
 S-404 APPROVED 29 JUN 2022 BY: _____ PLEASE REMIT
 S-405 PAYMENT DUE 29 JUN 2022
 S-406 POSTED 29 JUN 2022
 S-407 ENTERED 29 JUN 2022 BY: _____
 S-408 ENTERED 29 JUN 2022
 S-410 EMAILED 29 JUN 2022 BY: _____
 35% scale

S-400 ~ S-410	
S-414 / S-449 Date Printer	
SPARE PAD	S-400-7
SPARE PAD	S-400-7D
PACKING	
COLOR	1~4

S-311 +
 29 JUN 2022 - 29 JUN 2022



S-312 + or

P A I D F A X E D R E V I S E D
 E - M A I L E D R E C E I V E D S H I P P E D
 U R G E N T ! A P P R O V E D C H E C K E D
 C A N C E L L E D O V E R D U E C O M P L E T E D
 P A I D 29 JUN 2022

S-314 +
 or (S-314 Boxed packing only)

29 JUN 2022

Die Plate: Max. 10 x 25 mm

S-313 +
 1 2 3 4 5 6 7 8 9 0 1 2 3
 Special characters:
 / / / / / / / / / /



S-311 / S-312	
S-313 / S-314 Date Printer	
SPARE PAD	S-311-7
SPARE PAD	S-311-7B
PACKING	
COLOR	1~4



Elite Stamp



To insert a new ink pad

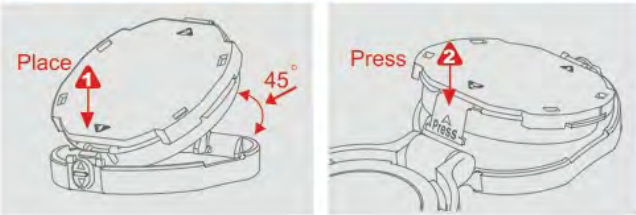

To dispose the used ink pad

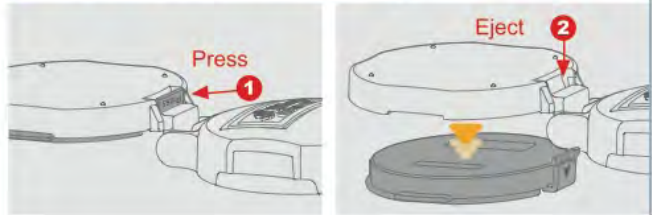

EL-42



ELF-42

EL-42	Self-Inking Stamp
SIZE OF IMPRINT	Ø 42 mm
SPARE PAD	Elite-42-7 
PACKING	
COLOR	1-6
compatible with	Ø 42mm Ø 32mm

ELF-42	Pre-Inked Stamp
SIZE OF IMPRINT	Ø 42 mm
PACKING	
COLOR	1-6
compatible with	Ø 42mm Ø 32mm

S-□□□ : Self-Inking Stamp
 Recommendation for die thickness: 2.3~2.6 mm

SP-□□□ : Pre-Inked Stamp
 Recommendation for die thickness: 3.0~4.5 mm

Stamp with style
Handy Stamp

An evolution from the renowned original Handy Stamp



Portable Yet Durable

A patented device for mobility, unique mechanisms design for operations to be easily made by one hand. Only 1/4 size of an ordinary, perfect to carry around.

	SIZE		COLOR	PACKING
S-722	14x38 mm	S-1722-7	1~11	
S-723	18x47 mm	S-1723-7	1~11	
S-724	25x58 mm	S-1724-7	1~11	

	SIZE	COLOR	PACKING
SP-722	14x38 mm	1~11	
SP-723	18x47 mm	1~11	
SP-724	25x58 mm	1~11	

COLOR · 1~11

- 1.Black 2.Blue 3.Fuchsia 4.Pink Pion 5.Green 6.African Violet 7.Ruby 8.Amethyst 9.Aquamarine 10.Gold 11.Silver



S-722 / SP-722



S-723 / SP-723



S-724 / SP-724

- **Smart** unique design for easy handling
- **Compact** perfect to carry around
- **Innovative** a patented device for mobility



	SIZE		PACKING
S-Q12	12x12 mm	S-Q12-7	
SP-Q12	12x12 mm		
S-Q17	17x17 mm	S-Q17-7	
SP-Q17	17x17 mm		
S-Q24	24x24 mm	S-Q24-7	
SP-Q24	24x24 mm		



S-Q12 / SP-Q12 S-Q17 / SP-Q17 S-Q24 / SP-Q24

COLOR · 1-8
 1.Black 2.Blue 3.Yellow 4.Red 5.Sky Blue
 6.Lavender 7.Spring Green 8.Sea Green



S-Q32 / S-Q32F	
SP-Q32	
SIZE OF IMPRINT	32 x 32 mm
SPARE PAD	S-Q32-7 
SPARE PAD	S-Q32-7F 
PACKING	
COLOR	1-4
1.Black 2.Blue 3.Yellow 4.Red	



S-Q32 / SP-Q32 S-Q32F



S-Q42 / S-Q42F	
SP-Q42	
SIZE OF IMPRINT	42 x 42 mm
SPARE PAD	S-Q42-7 
SPARE PAD	S-Q42-7F 
PACKING	
COLOR	1-4
1.Black 2.Blue 3.Yellow 4.Red	



S-Q42 / SP-Q42 S-Q42F



Fungistatic
agent built-in



In our daily life, we are surrounded by many unseen bacteria. These unseen bacteria could survive up to 3 days under ideal growth conditions.

Shiny's NTbac Line has fungistatic agent built-in during the manufacturing process. It has the ability to reduce up to 99.99% of bacteria.

The SGS report can be downloaded from the link below.
www.shinystamp.com/antibac.htm

Test Requested & Method: Reference
U.S. Pharmacopeia 26 NF 21
Microbiological Tests (51) Antimicrobial
Effectiveness Testing.

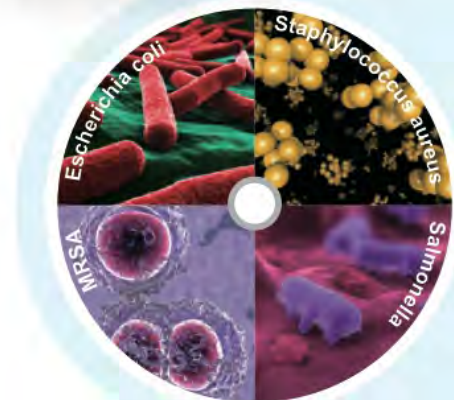

★ This stamp has been treated with a fungistatic agent to protect the product from fungal growth. This agent also retards the growth and action of bacterial odors.

RUSH A-841

Clearance SALE
WELCOME A-842

Jurong Bird Park
2 Jurong Hill
Singapore 628925
Tel: (+65) 6265 0022
Fax: (+65) 6261 1869
info@birdpark.com.sg A-843

Roxanne
of Art University
TEL: 886 2 2707-9889
FAX: 886 2 2827-9887 A-844

www.shinystamp.com
ECO Line
A-845

KEY POINT INT'L CORP.
9F NO. 6 LANE 142 SEC. 3 DA-AN RD.,
TAIPEI (106) TAIWAN, R.O.C.
TEL/FAX: 886 2 2707-9889 / 2 2707-7328 A-846



1. White 2. Black 3. Blue 4. Red

	SIZE	SPARE PAD	COLOR	PACKING
A-841	10 x 26 mm	S1821-7	1-4	
A-842	14 x 38 mm	S1822-7	1-4	
A-843	18 x 47 mm	S1823-7	1-4	
A-844	22 x 58 mm	S1824-7	1-4	
A-845	25 x 70 mm	S1825-7	1-4	
A-846	27 x 65 mm	S-846-7	1-4	



A-300
29 JUN 2022

A-309
1 2 3 4 5 6

Special characters:

NO
\$ - - - - -

A-300 / A-309 Mini Dater	
SPARE PAD	S-300-7
PACKING	
COLOR	1-3



A-400
29 JUN 2022

A-409
1 2 3 4 5 6

Special characters:

No Kg
\$ - X ¢ ½ %

A-414

AIR MAIL

AIR MAIL CHECKED
APPROVED FILE COPY
CANCELLED FIRST CLASS
CONFIDENTIAL CREDIT
CONFIRMATION OVERDUE
COPY URGENT!

Date Printer

A-400 / A-409 / A414	
SPARE PAD	S-400-7
PACKING	
COLOR	1-3



FILED
by Melissa Jones
A-722

Express
Délucieux
A-723

	SIZE	SPARE PAD	PACKING
NEW! A-722	14 x 38 mm	S-1722-7	
NEW! A-723	18 x 47 mm	S-1723-7	



Heavy Metal



- Metal
- Recycled PET
- Metal
- Soft rubber feet



With Die Plate



Without Die Plate (Bands Only)

Heavy Metal

17

Self-Inking Stamp / Self-Inking Dater

HM-6000

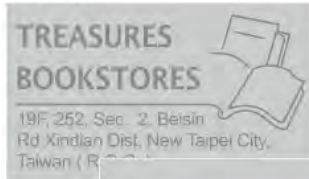

HM-61008



Special characters:



HM-6000 / HM-6100	
SIZE OF IMPRINT	24 x 41 mm
SPARE PAD	900-7
SPARE PAD	910-7
PACKING	

HM-6446/PL



Special characters:



HM-6100

HM-6440



HM-6446



Special characters:

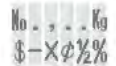

HM-6001



HM-6101

HM-61106



Special characters:



HM-6001 / HM-6101	
SIZE OF IMPRINT	32 x 38 mm
SPARE PAD	6001-7
SPARE PAD	6101-7
PACKING	

HM-6003



HM-6103

HM-61306



Special characters:

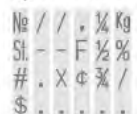

HM-61308



Special characters:



HM-6003 / HM-6103	
SIZE OF IMPRINT	30 x 50 mm
SPARE PAD	903-7
SPARE PAD	913-7
PACKING	

HM-6004



HM-61406



Special characters:



HM-6004 / HM-6104	
SIZE OF IMPRINT	26 x 56 mm
SPARE PAD	906-7
SPARE PAD	916-7
PACKING	

HM-6005



HM-61506



Special characters:



HM-6005 / HM-6105	
SIZE OF IMPRINT	45 x 45 mm
SPARE PAD	905-7
SPARE PAD	915-7
PACKING	

HM-61508



Special characters:



HM-6006



HM-61606



Special characters:

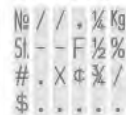

HM-6006 / HM-6106	
SIZE OF IMPRINT	33 x 56 mm
SPARE PAD	906-7
SPARE PAD	916-7
PACKING	

HM-61608



Special characters:



HM-6007



HM-61706

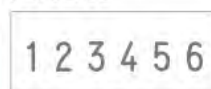

Special characters:



HM-6007 / HM-6107	
SIZE OF IMPRINT	40 x 60 mm
SPARE PAD	907-7
SPARE PAD	917-7
PACKING	

HM-61708

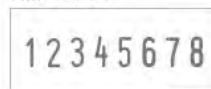

Special characters:



HM-6008



HM-61806



Special characters:

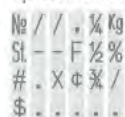

HM-61808



Special characters:



HM-6008 / HM-6108	
SIZE OF IMPRINT	47 x 68 mm
SPARE PAD	908-7
SPARE PAD	918-7
PACKING	

HM-6118DD		Special characters: \$
HM-6118DL		
HM-6118DR		

(Also available with number bands.)

HM-6708/PL 5mm-8 bands with plate



HM-6710/PL 5mm-10 bands with plate

Special characters:



Special characters:



HM-6708/PL	
HM-6710/PL	
SIZE OF IMPRINT	40 x 60 mm
SPARE PAD	907-7
PACKING	

HM-6558/PL 5mm-8 bands with plate



HM-6510/PL 5mm-10 bands with plate

HM-6558/PL
Special characters:



HM-6510/PL
Special characters:



HM-6558/PL	
HM-6510/PL	
SIZE OF IMPRINT	33 x 56 mm
SPARE PAD	906-7
PACKING	

HM-6770 Phrase & Dater
PAID 29 JUN 2022



HM-6770	
SPARE PAD	906-7
PACKING	

HM-6416/PL 4mm-16 bands with plate

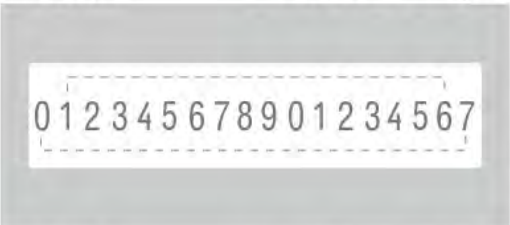

HM-6418/PL 4mm-18 bands with plate

Special characters:



Special characters:

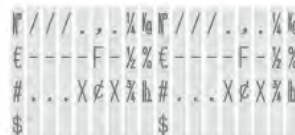

HM-6416/PL	
HM-6418/PL	
SIZE OF IMPRINT	30 x 68 mm
SPARE PAD	908-7
PACKING	



HM-6009



HM-6109



HM-6009 / HM-6109	
SIZE OF IMPRINT	∅ 45 mm
SPARE PAD	6009-7
SPARE PAD	6109-7
PACKING	

HM-6109-T12





HM-6109-T24



HM-6109-T12	
HM-6109-T24	
SIZE OF IMPRINT	∅ 41 mm
SPARE PAD	6109-7
PACKING	

Note: The die thickness of the HM-6109-T12 / HM-6109-T24 stamp must be 2.4-2.5mm.



HM-6014 / HM-6114	
SIZE OF IMPRINT	60 x 90 mm
SPARE PAD	6014-7 
SPARE PAD	6114-7 
PACKING	

HM-6014



HM-6114

HM-61146

1 2 3 4 5 6

Special characters:

№ / / . % Kg
 St. - - F ½ %
 # . X ¢ % /
 \$

HM-61148

1 2 3 4 5 6 7 8

Special characters:

- - - - -
 / / / / / / / /



HM-6114DD

Special characters:

№ / / . % Kg
 St. - - F ½ %
 # . X ¢ % /
 \$





HM-6114DL
 HM-6114DR

(Also available with number bands.)

HM-6015



HM-6115

HM-6015 / HM-6115	
SIZE OF IMPRINT	65 x 116 mm
SPARE PAD	6015-7 
SPARE PAD	6115-7 
PACKING	

HM-61156

1 2 3 4 5 6

Special characters:

№ / / . % Kg
 St. - - F ½ %
 # . X ¢ % /
 \$

HM-61158

1 2 3 4 5 6 7 8

Special characters:

- - - - -
 / / / / / / / /

HM-6115DD



HM-6115DL · HM-6115DR



Special characters:

№ / / . % Kg
 St. - - F ½ %
 # . X ¢ % /
 \$

(Also available with number bands.)



With environmental threats and degradation such as deforestation in mind, Shiny has introduced a series of products using 75% post consumer recycled material that pack with recycled fiber in its ECO Line.

PET Bottle Flake Production

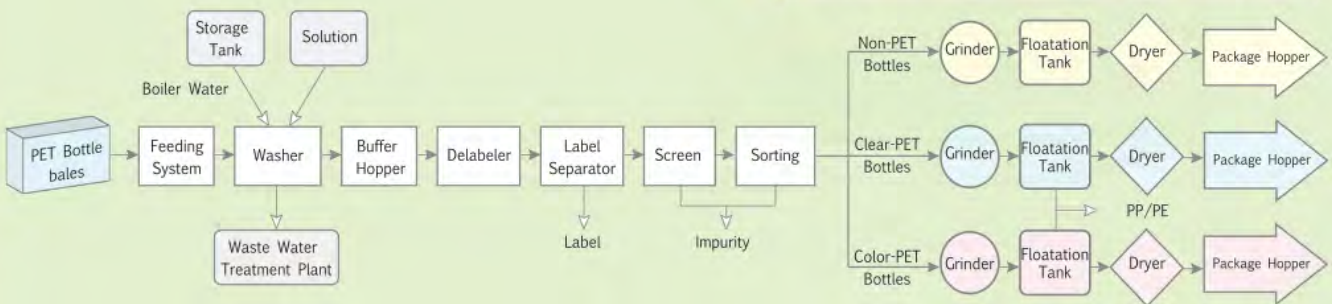

Recycled ABS: The material has been certified by Plastics Industry Development Center.

Recycled PET: The material has been certified by Scientific Certification Systems (S.C.S.)



ES-722

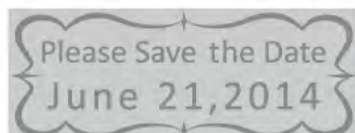

ES-723

	SIZE		PACKING
ES-722	14 x 38 mm	S-722-7	
ES-723	18 x 47 mm	S-723-7	



842



843



844



846



PET-□□□ : PET (Recycled)



ES-□□□ : ABS (Recycled)

	SIZE		PACKING
842	14 x 38 mm	S1822-7	
843	18 x 47 mm	S1823-7	
844	22 x 58 mm	S1824-7	
846	27 x 65 mm	S-846-7	



□□□-300

29 JUN 2022

□□□-309

Special characters:

1 2 3 4 5 6

No.
\$ - - - - -



300 / 309	Mini Dater
SPARE PAD	S-300-7
PACKING	



□□□-414

AIR MAIL

AIR MAIL CHECKED
APPROVED FILE COPY
CANCELLED FIRST CLASS
CONFIDENTIAL CREDIT
CONFIRMATION OVERDUE
COPY URGENT!

□□□-400

29 JUN 2022



400 / 409	Date Printer
414	
SPARE PAD	S-400-7
PACKING	

□□□-409

Special characters:

1 2 3 4 5 6

No.
\$ - X ¢ %



□□□-3600

PET(Recycled)

More PET-3600 / ES-3600 die plate sizes can be found in page 54

3600 Die-Plate Date Stamp	
SIZE OF IMPRINT	PACKING
1. 35 x 50 mm	
2. 35 x 55 mm	
3. 40 x 55 mm	
4. 40 x 60 mm	
5. 50 x 70 mm	
6. ∅ 51 mm	
7. 51 x 51 mm	
8. 44 x 67 mm	
DATER BAND SIZE · 7 x 30 mm	
29 JUN 2022	

Essential Line Heavy Duty



Soft Handle

The handle will not cramp your hands, and the soft material provides a comfortable feel.

Elegant Design

The metal frame structure leads to an elegant feeling of design that sets apart from the stereotype.

Lock Button

The lock ensures easy operation for stamp makers, and for the users when changing ink pad and adjusting dates or numbers.

Solid Structure

The curved metal frame ensures durability for frequent use. The new silent device allows quieter and smoother movement.

The Essential Line and Heavy Duty also feature non-slipping feet that keep the stamp in place while making imprints.

Full Size Display Window

Full-size display window clearly shows the actual impression of the stamp.

Band Cover

Our 12-years date bands (guaranteed minimum of 11 years) have a protective cover, thus making it impossible to contaminate your fingers when changing the dates.



Essential Line



Heavy Duty

H-6000 · E-900



H-6100 · E-910

H-61008 · E-91008



H-6446/PL · E-946/PL

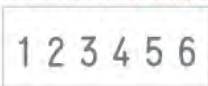

H-6440 · E-940



Special characters:



Special characters:

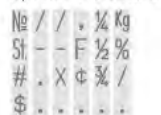

H-6000 / H-6100

E-900 / E-910

SIZE OF IMPRINT 24 x 41 mm

SPARE PAD 900-7

SPARE PAD 910-7

PACKING

H-6446 · E-946

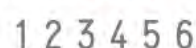

Special characters:

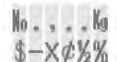



Essential Line



Heavy Duty

Item number is distinguished by E and H

1 2 3 4 5 6

With Die Plate

1 2 3 4 5 6

Without Die Plate (Bands Only)

H-6001 · E-901



H-61106

1 2 3 4 5 6

Special characters:

\$. , - /

H-6101 · E-911

H-6001 / H-6101

E-901 / E-911

SIZE OF IMPRINT 32 x 38 mm

SPARE PAD 6001-7

SPARE PAD 6101-7

PACKING

H-6003 · E-903



H-61306 · E-91306

1 2 3 4 5 6

Special characters:

No / / , % Kg
St - - F 1/2 %
. X ¢ % /
\$

H-6103 · E-913

H-6003 / H-6103

E-903 / E-913

SIZE OF IMPRINT 30 x 50 mm

SPARE PAD 903-7

SPARE PAD 913-7

PACKING

H-6004 · E-904



H-61406 · E-91406

1 2 3 4 5 6

Special characters:

No / / , % Kg
St - - F 1/2 %
. X ¢ % /
\$

H-6104 · E-914

H-6004 / H-6104

E-904 / E-914

SIZE OF IMPRINT 26 x 56 mm

SPARE PAD 906-7

SPARE PAD 916-7

PACKING

H-6005 · E-905



H-61506 · E-91506

1 2 3 4 5 6

Special characters:

No / / , % Kg
St - - F 1/2 %
. X ¢ % /
\$

H-6105 · E-915

H-6005 / H-6105

E-905 / E-915

SIZE OF IMPRINT 45 x 45 mm

SPARE PAD 905-7

SPARE PAD 915-7

PACKING

H-61508 · E-91508

1 2 3 4 5 6 7 8

Special characters:

/ / / / / / / /

H-6006 · E-906



H-6106 · E-916

H-61606 · E-91606



Special characters:

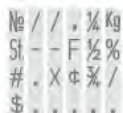

H-61608 · E-91608



Special characters:



H-6006 / H-6106	
E-906 / E-916	
SIZE OF IMPRINT	33 x 56 mm
SPARE PAD	906-7
SPARE PAD	916-7
PACKING	

H-6007 · E-907



H-6107 · E-917

H-61706 · E-91706



Special characters:

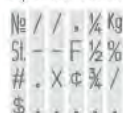

H-61708 · E-91708

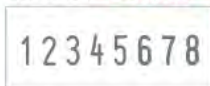

Special characters:



H-6007 / H-6107	
E-907 / E-917	
SIZE OF IMPRINT	40 x 60 mm
SPARE PAD	907-7
SPARE PAD	917-7
PACKING	

H-6008 · E-908



H-6108 · E-918

H-61806 · E-91806

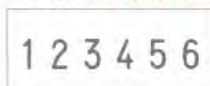

Special characters:

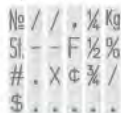

H-61808 · E-91808

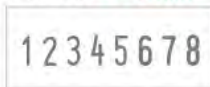

Special characters:



H-6008 / H-6108	
E-908 / E-918	
SIZE OF IMPRINT	47 x 68 mm
SPARE PAD	908-7
SPARE PAD	918-7
PACKING	

H-6118DD · E-918DD



Special characters:



H-6118DL · E-918DL
H-6118DR · E-918DR

(Also available with number bands.)

H-6708/PL · E-9708/PL 5mm-8 bands with plate

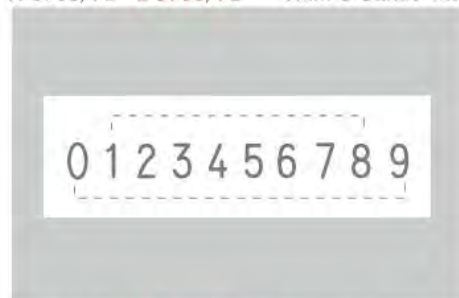

H-6710/PL · E-9710/PL 5mm-10 bands with plate

Special characters:



Special characters:



H-6708/PL / H-6710/PL	
E-9708/PL / E-9710/PL	
SIZE OF IMPRINT	40 x 60 mm
SPARE PAD	907-7
PACKING	

H-6558/PL · E-958/PL 5mm-8 bands with plate



H-6510/PL · E-9510/PL 5mm-10 bands with plate

H-6558 · E-958 5mm-8 bands
0 1 2 3 4 5 6 7 8 9
H-6510 · E-9510 5mm-10 bands

Special characters:

№ / / / / / , ¼ Kg
€ - - - - - F ½ %
. . . X ¢ % /
\$

Special characters:

№ / / / / / / / / /
€ - - - - - F - - -
. ¢ . . .
\$

H-6558/PL / H-6510/PL	
E-958/PL / E-9510/PL	
SIZE OF IMPRINT	33 x 56 mm
SPARE PAD	906-7
PACKING	

H-6770	E-970
SPARE PAD	906-7
PACKING	

PAID 29 JUN 2022
H-6770 · E-970 Phrase & Dater

H-6416/PL · E-9416/PL 4mm-16 bands with plate



H-6418/PL · E-9418/PL 4mm-18 bands with plate

Special characters:

№ / / . . . ¼ Kg № / / . . . ¼ Kg
€ - - - F - ½ % € - - - F - ½ %
. . X ¢ X % ¢ # . . X ¢ X % ¢
\$ \$

Special characters:

№ / / / . . . ¼ Kg № / / / . . . ¼ Kg
€ - - - - F - ½ % € - - - - F - ½ %
. . . X ¢ X % # . . . X ¢ X %
\$ \$

H-6416/PL / H-6418/PL	
E-9416/PL / E-9418/PL	
SIZE OF IMPRINT	30 x 68 mm
SPARE PAD	908-7
PACKING	

H-6416 · E-9416 4mm-16 bands
0 1 2 3 4 5 6 7 8 9 0 1 2 3 4 5 6 7
H-6418 · E-9418 4mm-18 bands



H-6009

H-6109



H-6109-T12

H-6109-T24



H-6010

H-6110

H-6009 / H-6109	
SIZE OF IMPRINT	∅ 45 mm
SPARE PAD	6009-7
SPARE PAD	6109-7
PACKING	

H-6109-T12	
H-6109-T24	
SIZE OF IMPRINT	∅ 41 mm
SPARE PAD	6109-7
PACKING	
Note: The die thickness of the H-6109-T12 / H-6109-T24 stamp must be 2.4-2.5mm.	

H-6010 / H-6110	
SIZE OF IMPRINT	∅ 42 mm
SPARE PAD	6009-7
SPARE PAD	6109-7
PACKING	



DUO

One for ALL!!

Over 100 print sizes available

With environmental threats and degradation such as deforestation in mind, Shiny is delighted to introduce DUO, a revolutionary hand stamp designed to replace conventional wooden stamps. Shiny's DUO not only provides a multitude of print sizes, but permits more versatility and greater possibility than outdated wooden models.



Shiny's DUO Features and Benefits

- Customer can mix & match handle to stamp mount freely.
- Inventory control: handle and stamp mount can be disassembled to save space.
- Stamp mounts can be converted to Pre-Inked style at customer request.
- Compact handle permits easy portability in any briefcase or purse.
- More than 100 print sizes available.

Available options



Hand Stamp



Hand Stamp

+
Cover with
Ink Pad



Portable Handle

+
Cover



Hand Stamp

+
Cover



Flash Stamp
(Pre-Inked)

+
Cover

▶▶▶ **Remarks on die plate**

Use DUO as Rubber Stamp: (We recommend adding cushion to rubber sheet on big print sizes)
 Die thickness: 2.3~3.5 mm (Option: Cushion CU-003)

When coupling with Cover + Ink Pad option, we recommend setting the die thickness 2.3 mm ← Rubber Sheet + 1 mm ← Cushion to maximize best inking impression.

Use DUO as Flash Stamp (Pre-Inked)
 Appropriate die thickness: 5.0 mm

Example:
 Flash sheet: FS-1025
 Cartridge: CS-1025

Accessory:
 Adhesive sticker: ST-002 (size: 210 x 297 mm)
 Cushion: CU-003 (adhesive tape, size: 360 x 360 x 1 mm)
 Flash sheet: FS-□□□□ (W x L mm)
 Cartridge: CS-□□□□ (W x L mm)
 Glue: G-01 (specifically for holding the flash sheet and cartridge)



The carefully chosen SHINY accessories have been tested on machinery over 300,000 impressions. To utilize full benefits, please choose genuine SHINY parts.

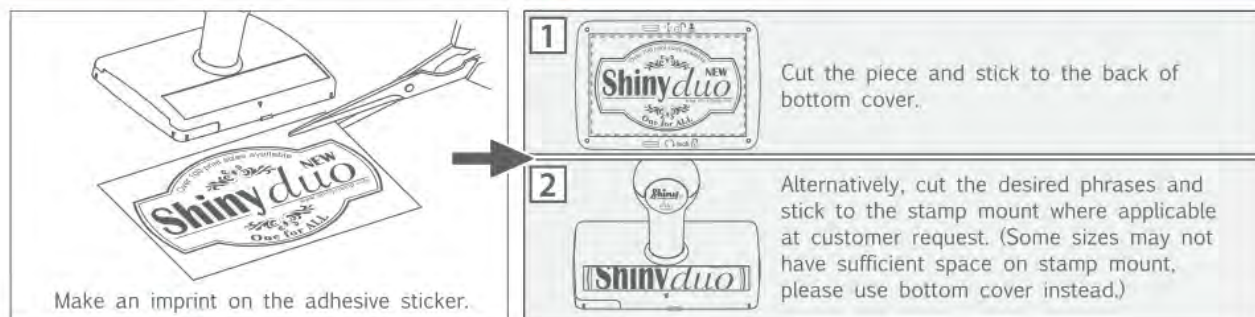

Suitable for using with Pre-Inked Stamp



Item No: M□-□□ □□□ (W x L mm)

Compatible with DH-00 (DH-12)



Compatible with DH-00 (DH-12)

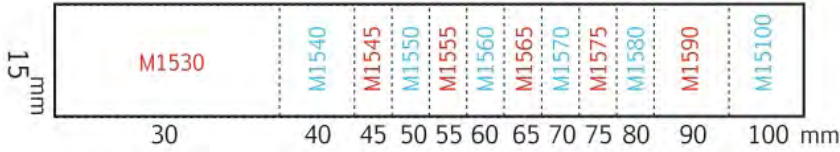

Compatible with DH-01 (DH-02)

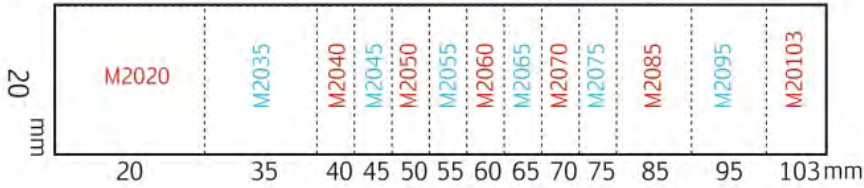

Compatible with DH-01 (DH-02)

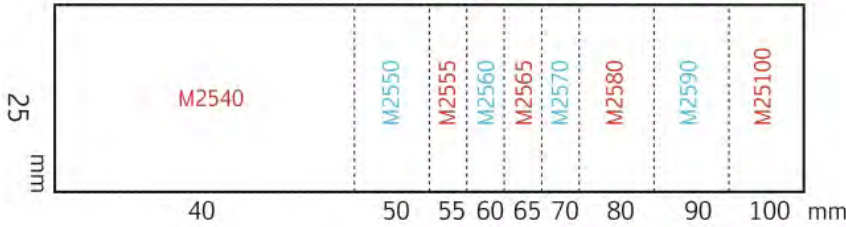

DH-01 (DH-02) ↔ DH-03 (DH-04)

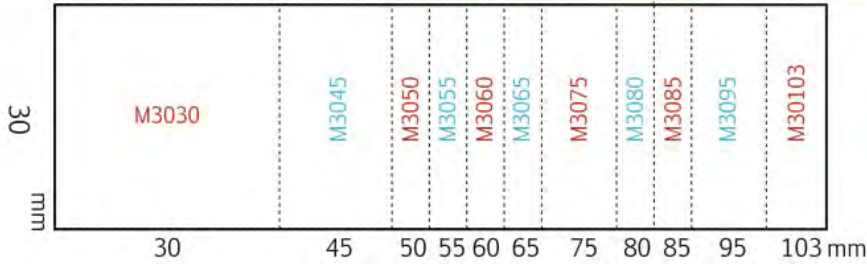

DH-01 (DH-02) ↔ DH-03 (DH-04)

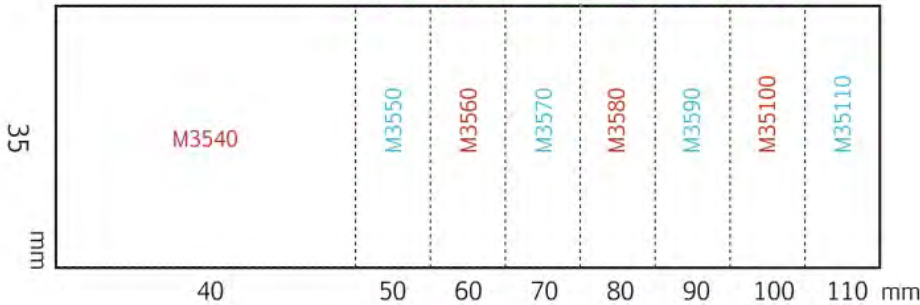

DH-01 (DH-02) ↔ DH-03 (DH-04)

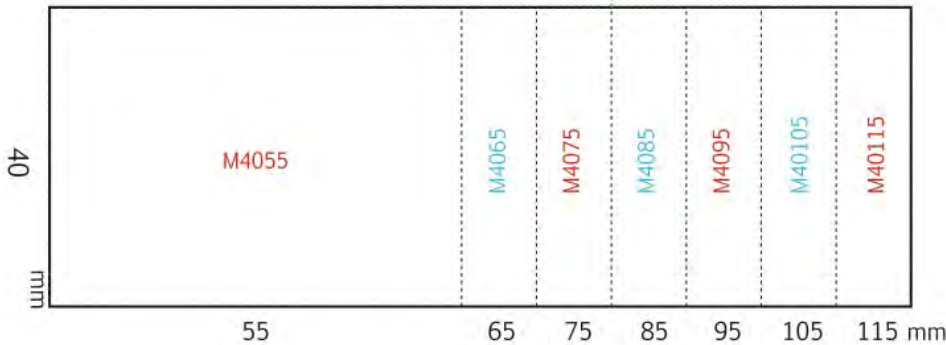

Handle	
DH-00	Small Handle (Smaller diameter)
DH-01	Small Handle
DH-12	Portable Handle (Smaller diameter)
DH-02	Portable Handle
DH-03	Large Handle
DH-04	Spring Handle (Large)

Possible combinations	
ie. DUO M1025	
Stamp mount	M1025
Cover with Ink Pad	M1025-7
Cover	M1025-8
Stamp mount + Cover with Ink Pad	M1025+7
Stamp mount + Cover	M1025+8

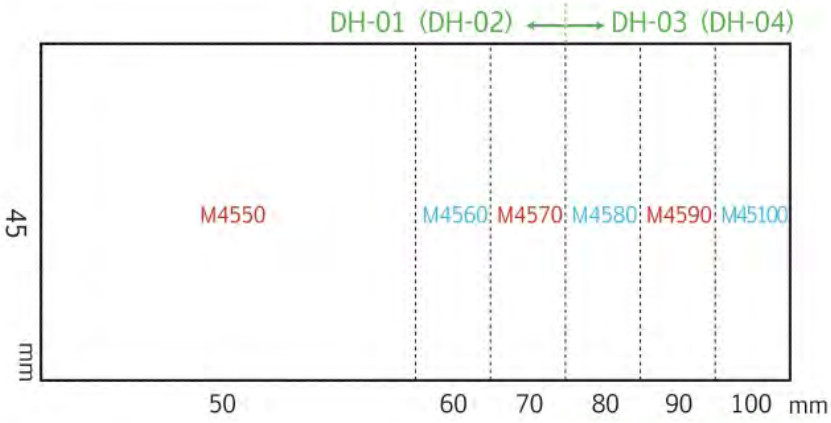

Compatible with DH-01 (DH-02)

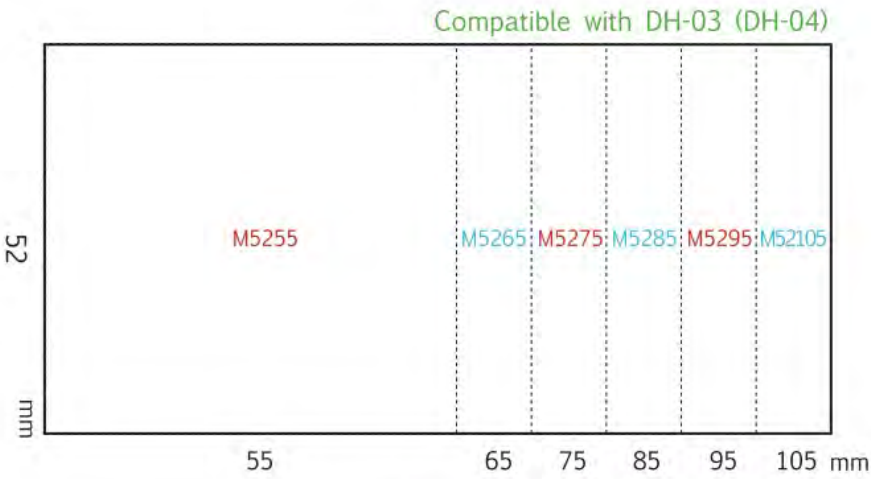
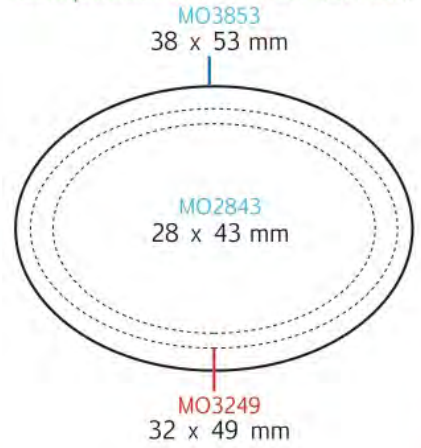

Compatible with DH-03 (DH-04)

MR17~MR43 are compatible with DH-01 (DH-02)
MR50 is compatible with DH-03 (DH-04)

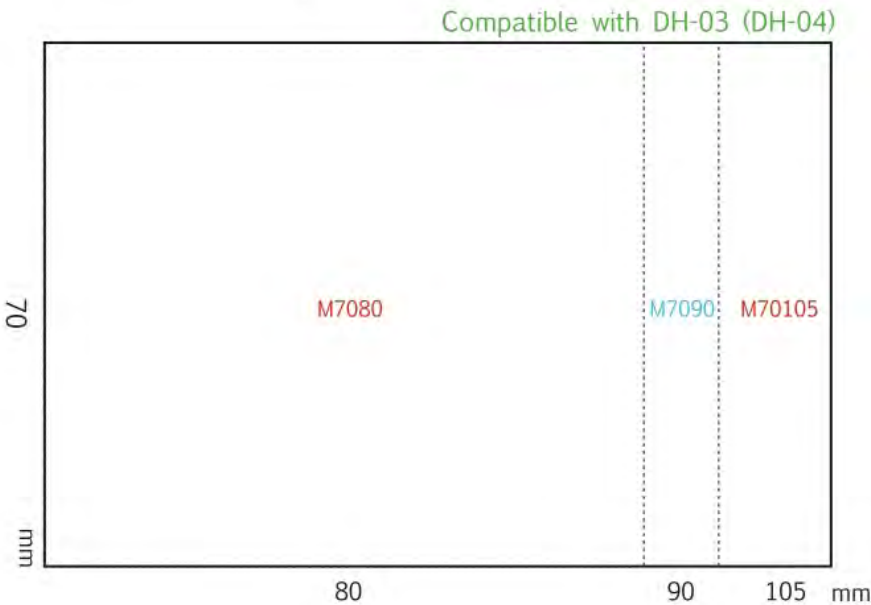
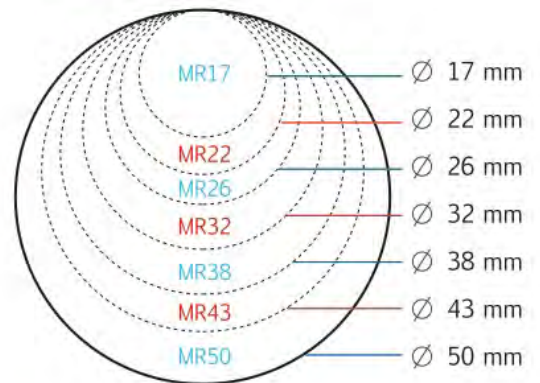
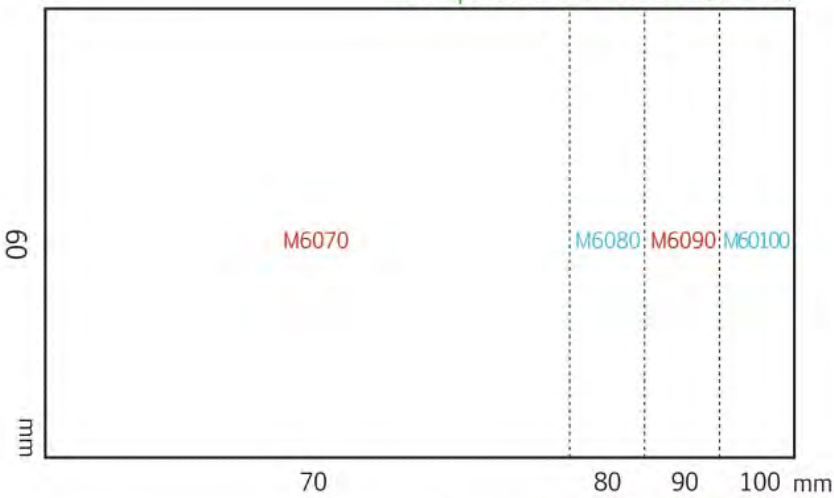

Compatible with DH-01 (DH-02)

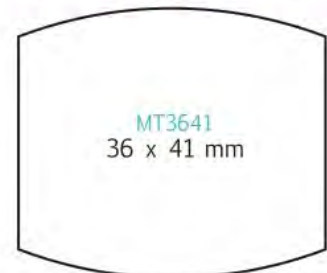

Embossing Seal

Int. Pat.

The total thickness of die material is recommended to set to **3.5-3.8mm** (exclude the adhesive material) for best handling and imprint results.

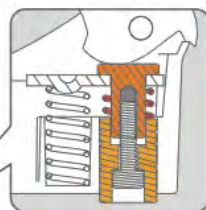
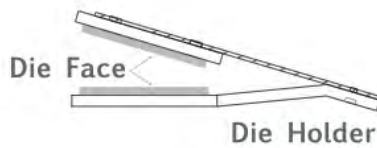

Pressure Reduction Mechanism



EG Desk Seals	
SIZE	48 x 156 x 117 mm
PACKING	(Gift box set)
COLOR	1~5

DIE HOLDER	MODEL
EM-5	∅ 41 mm
EM-6	25 x 50 mm
EM-7	∅ 50 mm
EM-8	41 x 41 mm
EM-9	Compatible for ∅20 mm, ∅31 mm, 20 x 20 mm and 31 x 31 mm

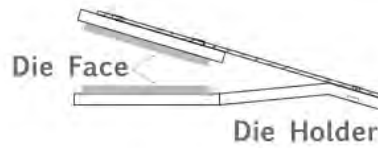

- The soft rubber insert makes it comfortable when holding with palm. This softness in leverage also makes it easier to have protrudent embossments.
- Reinforced high strengthen steel is used in the construction, which ensures durability, quality, and rigidity.
- The pocket type embossing seal comes with a plastic case that makes it convenient to store and compact to carry.
- Compatible with EM-5, EM-6, EM-8, and EM-9.

Compatible Die-Holder for EG/ES/EM/ED :

Die Holder	Seal	EG	ES	EM	ED
EM-5		●	●	●	●
EM-6		●	●	●	●
EM-7		●	●	●	●
EM-8		●	●	●	●
EM-9		●	●	●	●

ES Pocket Seals	
SIZE	28 x 115 x 54 mm
PACKING	
COLOR	5

DIE HOLDER	MODEL
EM-5	∅ 41 mm
EM-6	25 x 50 mm
EM-8	41 x 41 mm
EM-9	Compatible for ∅20 mm, ∅31 mm, 20 x 20 mm and 31 x 31 mm

EM-9

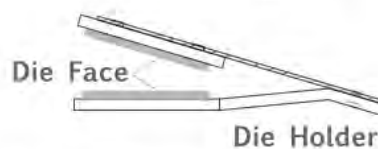
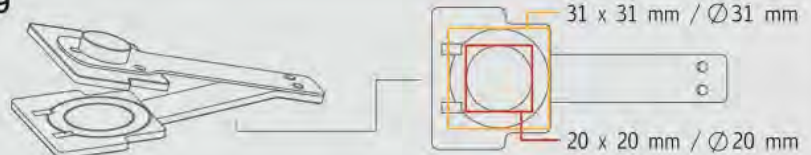

- The soft rubber insert makes it comfortable when holding with palm. This softness in leverage also makes it easier to have protrudent embossments.
- Reinforced high strengthen steel is used in the construction, which ensures durability, quality, and rigidity.
- The pocket type embossing seal comes with a plastic case that makes it convenient to store and compact to carry.
- Compatible with EM-5, EM-6, EM-8, and EM-9.

EM Pocket Seals	
SIZE	28 x 126 x 58 mm
PACKING	
COLOR	6

DIE HOLDER	MODEL
EM-5	∅ 41 mm
EM-6	25 x 50 mm
EM-8	41 x 41 mm
EM-9	Compatible for ∅20 mm, ∅31 mm, 20 x 20 mm and 31 x 31 mm

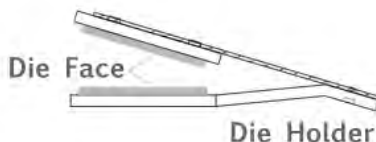

- Reinforced high strength steel is used in the construction, which ensures durability, quality, and rigidity.
- Unique and beautiful finish adds bonus to its excellent mechanism.
- Pressure reduction mechanism.

ED Desk Seals	
SIZE	53 x 115 x 62 mm
PACKING	
COLOR	Black
DIE HOLDER	MODEL
EM-5	∅ 41 mm
EM-6	25 x 50 mm
EM-7	∅ 50 mm
EM-8	41 x 41 mm

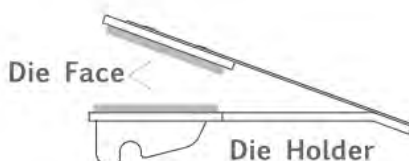

- Reinforced high strength steel is used in the construction, which ensures durability, quality, and rigidity.
- Unique and beautiful finish adds bonus to its excellent mechanism.
- Pressure reduction mechanism.

EH Heavy Duty Seals	
SIZE	56 x 157 x 93 mm
PACKING	
COLOR	Black
DIE HOLDER	MODEL
EH-2	∅ 50 mm
EH-3	50 x 50 mm

• The Smart Base is compatible with both ES and EM seal frame. When pairing with EM frame, please leave the spacers (see where indicated below) at their positions, and remove the spacers when using with ES frame.

Int Pat.



EB Smart Base NEW!	
SIZE	56 x 157 x 93 mm
PACKING	
COLOR	Black

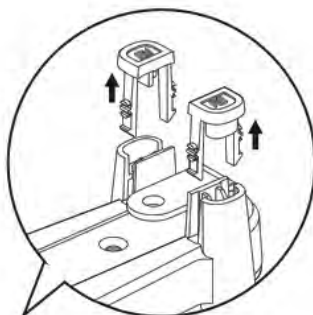

Deluxe Pouch NEW!	
SIZE	109 x 150 mm
COLOR	Black

(for ES/EM)



Seals Accessories



CS-1 · Gold / CS-2 · Silver / CS-3 · Red / CS-4 · Green

Craft sticker for Embossing Seal

SIZE	∅ 41 mm (24 pcs per A4 sheet)
SIZE	∅ 50 mm (15 pcs per A4 sheet)



SPS-1

SIZE	279 x 305 mm
THICKNESS	2.1 mm
Die face material for embossing seal (suitable for laser engraving)	



Seal Impression Inker **NEW!**

SIZE	∅ 41 mm (EP-1)
SIZE	∅ 50 mm (EP-2)

Die / Die Holder

EM-1 (standard)

size: ∅ 41 mm
(for EG/ES/EM/ED)



EM-2 (standard)

size: 25 x 50 mm
(for EG/ES/EM/ED)



EM-3 (standard)

size: ∅ 50 mm
(for EG/ED)



EM-5 (laser)

size: ∅ 41 mm
(for EG//ES/EM/ED)



EM-6 (laser)

size: 25 x 50 mm
(for EG/ES/EM/ED)



EM-7 (laser)

size: ∅ 50 mm
(for EG/ED)



EM-8 (laser)

size: 41 x 41 mm
(for EG/ES/EM/ED)



EM-9 (laser)

size: ∅ 20 mm ∅ 31 mm
size: 20 x 20 mm 31 x 31 mm
(for EG/ES/EM)



EH-1 (standard)

size: ∅ 50 mm
(for EH)



EH-2 (laser)

size: ∅ 50 mm
(for EH)



EH-3 (laser)

size: 50 x 50 mm
(for EH)



Metal dies

(for EM-1/EM-2/EM-3/EH-1)



Brass dies

(for EM-1/EM-2/EM-3/EH-1)





Textile Labeling Kit

Washing resistant label for your laundry



A quick and easy way to identify your clothes and personal belongings.

It is simple to use and laundry wash resistant.



CTA. No. _____
BANCO _____

TL-842

TL-842	
SIZE OF IMPRINT	14 x 38 mm
SPARE PAD	TL-842-7 
PACKING	
COLOR	Blue

CONTAINS	
Printing stamp	1
Stamp pad (Dry)	1
Labeling tape (3 yards)	1
Textile ink (10ml)	1



B.H. PLUMBERS
HENRY STERN
2861 6261828

TL-882

Insert up to 3 lines of texts.

TL-882	
SIZE OF IMPRINT	14 x 38 mm
SPARE PAD	TL-842-7 
PACKING	
COLOR	Blue

CONTAINS	
Printing stamp	1
Rubber type plate	1
Stamp pad (Dry)	1
Tweezers	1
Labeling tape (3 yards)	1
Textile ink (10ml)	1
RUBBER TYPE	
4mm - 256 characters	



TL-842-7	
SPARE PAD	Dry
PACKING	



TL-ST-1	
Textile Ink (10ml)	Black
PACKING	



TL-TAPE	
Labeling Tape	2 x (3 yards)
PACKING	

Stock Stamp

Self-Inking OA



▲ Stock Stamp Display PI-024

OA

Pre-Inked Stamp

Functional Protective Cover

Functional protective cover for daily use and easy storage.

For daily use, place the stamp on the "unlock" side of the cover. When not in use, turn the stamp to the other side to lock for easy storage.

Full Size Index Window

The index window shows the full imprint in the actual size.

Easy Positioning Indicator

The easy positioning indicator enables the user to precisely stamp in the desired position.

Releasable Plate

Designed for easier ink-refilling, simply press the release buttons to release the plate from the stamp.

New Concept

Creative and functional design combining traditional rubber stamp form with the development of new technology.

Soft Handle

Comfortable and easy handling with soft handle that is suitable for long term use.





COPY

▲ ACTUAL IMPRESSION



OA Pre-Inked Stamp	
PACKING	
INK COLOR	■ RED ■ BLUE

TEN001		CONFIDENTIAL	TEN011		URGENT	TEN021		VOID
TEN002		ORIGINAL	TEN012		APPROVED	TEN022		COMPLETED
TEN003		COPY	TEN013		CONFIDENTIAL	TEN023		COPY
TEN004		FAXED	TEN014		DRAFT	TEN024		E-MAILED
TEN005		FILE	TEN015		FAXED	TEN025		FILE
TEN006		RECEIVED	TEN016		FILE COPY	TEN026		for deposit only
TEN007		POSTED	TEN017		MAILED	TEN027		ORIGINAL
TEN008		VOID	TEN018		PAID	TEN028		PAST DUE
TEN009		PAID	TEN019		POSTED	TEN029		RECEIVED
TEN010		CANCELLED	TEN020		REVISED	TEN030		SCANNED

Color	Item No.	Capacity
■ Red	SO-62	10 ml
■ Blue	SO-63	10 ml



PRE-INKED STAMP
x 3-4 drops



NEW OA
x 3 drops



ORIGINAL OA
x 3 drops



Refill Ink Pre-inked Stamp Ink	
PACKING	

PLEASE NOTE

The Pre-inked Stamp Ink is for OA Pre-inked Stamp use only.

TO REFILL INK

Add 3-4 drops of Shiny Pre-inked Stamp Ink to both tubes for best results.





ACTUAL IMPRESSION
Size :13 X 13 mm

OA Stamp

SIZE OF IMPRINT 13 x 13 mm

INK COLOR ■ RED ■ BLUE



▲ Pre-Inked Stamp Display
PI-040

HS001	HS002	HS003	HS004	HS005	HS006	HS007	HS008	HS009	HS010	HS011
HS012	HS013	HS014	HS015	HS016	HS017	HS018	HS019	HS020	HS021	HS022
HS023	HS024	HS025	HS026	HS027	HS028	HS029	HS030	HS031	HS032	HS033
HS034	HS035	HS036	HS037	HS038	HS039	HS040	HS041	HS042	HS043	HS044
HS045	HS046	HS047	HS048	HS049	HS050	HS051	HS052	HS053	HS054	HS055
HS056	HS057	HS058	HS059	HS060	HS061	HS062	HS063	HS064	HS065	HS066
HS067	HS068	HS069	HS070	HS071	HS072	HS073	HS074			

- EN-□□□ · ORIGINAL OA (Pre-inked)
- N-□□□ · NEW OA (Pre-inked)
- S-□□□□ · STOCK STAMP (Self-Inking)

All available with red ink.
Blue ink is available with  mark.

OA Stamp



Stock Stamp

Replace new pad with pad S-852-7

Packaging



S- N- EN-

INK COLOR

■ RED
 ■ BLUE

ENGLISH TITLES 1-Color	ACTUAL IMPRESSION
PAID	EN109 CONFIDENTIAL NC17 STC17
EN006 AIRMAIL NA01 STA01	EN111 CANCELLED NC18 STC18
EN170 AIR MAIL NA02 STA02	EN174 CANCELLED NC19 STC19
EN133 AIR MAIL NA03 STA03	EN212 CANCELLED NC20 STC20
EN009 APPROVED NA04 STA04	EN121 CONFIRMATION NC21 STC21
EN171 APPROVED NA05 STA05	EN169 CONFIRMATION OF FACSIMILE NC22 STC22
EN155 APPROVED FOR PAYMENT NA06 STA06	EN148 CASH SALE NC23 STC23
EN124 A/C PAYEE ONLY NA07 STA07	EN209 COPY SENT NC24 STC24
EN218 A/C PAYEE ONLY NA08 STA08	EN213 CHARGED NC25 STC25
EN907 AMENDMENT NA09 STA09	EN905 CONSIGNMENT NC26 STC26
EN914 AMENDED NA10 STA10	L208 Certified True Copy NC27 STC27
EN162 BY HAND NB01 STB01	L209 CERTIFIED TRUE COPY NC28 STC28
EN216 BILLED NB02 STB02	NC29 CONTROLLED COPY STC29
EN002 COPY NC01 STC01	EN935 CHECK SPELLING NC30 STC30
EN175 COPY NC02 STC02	EN015 DRAFT ND01 STD01
EN004 CHECKED NC03 STC03	EN179 DRAFT ND02 STD02
EN172 CHECKED NC04 STC04	EN107 DUPLICATE ND03 STD03
EN005 C.O.D. NC05 STC05	EN116 DELIVERED ND04 STD04
EN176 C.O.D. NC06 STC06	EN143 DO NOT BEND ND05 STD05
EN016 COMPLETED NC07 STC07	EN011 EXPRESS NE01 STE01
EN173 COMPLETED NC08 STC08	EN017 ENTERED NE02 STE02
EN018 CONFIRM NC09 STC09	EN208 ENTERED NE03 STE03
EN177 CONFIRM NC10 STC10	EN922 EXCELLENT NE04 STE04
EN178 CONFIRMED NC11 STC11	EN926 E-MAILED NE05 STE05
EN918 CONFIRMED NC12 STC12	EN927 E-MAIL NE06 STE06
EN023 CREDIT NC13 STC13	EN012 FILED NF01 STF01
EN024 CARD ONLY NC14 STC14	EN184 FILED NF02 STF02
EN103 CASH NC15 STC15	EN019 FRAGILE NF03 STF03
EN199 CASH NC16 STC16	EN104 FILE NF04 STF04
	EN182 FILE NF05 STF05
	EN112 FOR DEPOSIT ONLY NF06 STF06
	EN130 FIRST CLASS MAIL NF07 STF07
	EN131 FINAL NOTICE NF08 STF08
	EN132 FILE COPY NF09 STF09
	EN183 FAX NF10 STF10
	EN908 FAX NF11 STF11
	EN166 FAX IN NF12 STF12
	EN917 FAX IN/OUT NF13 STF13
	EN180 FAX IN NF14 STF14
	EN206 FAX IN NF15 STF15
	EN181 FAX OUT NF16 STF16
	EN207 FAXOUT NF17 STF17
	EN204 FAXED NF18 STF18
	EN906 FAXED NF19 STF19
	EN913 FAXED NF20 STF20
	EN920 GOOD NG01 STG01
	EN902 HAND NH01 STH01
	L241 HAND NH02 STH02
	EN008 IMPORTANT NI01 STI01
	EN013 IN NI02 STI02
	EN219 IN NI03 STI03
	EN022 INSPECTED NI04 STI04
	EN144 INVOICE NI05 STI05
	EN185 INVOICE NI06 STI06
	EN916 ISSUED NI07 STI07
	EN919 IMPROVING NI08 STI08
	EN928 IMMEDIATE NI09 STI09
	NI10 IMMEDIATE ATTENTION STI10
	EN936 INCOMPLETE PLEASE FINISH NI11 STI11
	EN933 MORE CARE REQUIRED NM01 STM01
	EN114 NOT NEGOTIABLE NN01 STN01
	EN154A NOT NEGOTIABLE NN02 STN02
	EN149 NET 7 DAYS NN03 STN03
	EN150 NET 14 DAYS NN04 STN04
	EN151 NET 30 DAYS NN05 STN05
	EN153 NON NEGOTIABLE A/C PAYEE ONLY NN06 STN06
	EN154 NOT NEGOTIABLE A/C PAYEE ONLY NN07 STN07
	EN924 NOT TRANSFERABLE A/C PAYEE ONLY NN08 STN08
	EN925 NOT TRANSFERABLE NN09 STN09
	EN014 OUT NO14 STO14
	EN220 OUT NO20 STO20
	EN117 ORIGINAL NO33 STO33
	EN188 ORIGINAL NO44 STO44
	EN211 ORDERED NO55 STO55
	EN186 OVERDUE NO66 STO66
	EN187 OK NO77 STO77
	EN934 ON TARGET NO88 STO88
	EN001 PAID NP01 STP01
	EN101 Paid NP02 STP02
	EN191 PAID NP03 STP03
	EN201 PAID NP04 STP04
	EN221 PAID NP05 STP05
	EN912 PAID NP06 STP06
	EN119 PRINTED MATTER NP07 STP07
	EN192 PRINTED MATTER NP08 STP08
	EN122 PARCEL POST NP09 STP09
	EN125 PLEASE REMIT NP10 STP10
	EN127 PROCESSED NP11 STP11
	EN128 PRIORITY NP12 STP12
	EN137 PREPAID NP13 STP13

□□-□□□ · Pre-inked OA
 □□□-□□□□ · STOCK STAMP (Self-Inking)

All available with red ink.
 Blue ink is available with ■ mark.



Stock Stamp

Replace new pad
 with pad S-852-7

OA Stamp

Packaging



INK COLOR

■ RED ■ BLUE

FRENCH TITLES

1-Color

EXPRESS

FR002 SFR002 EXPRESS

FR003 SFR003 IMPRIMÉS

FR004 SFR004 DUPLICATA

FR005 SFR005 PERSONNEL

FR006 SFR006 LETTRE

FR008 SFR008 DEVIS

FR009 SFR009 RAPPEL

FR019 SFR019 PAYÉ

FR021 SFR021 COPIE

FR023 SFR023 BON DE LIVRAISON

FR101 SFR101 RECOMMANDÉ

FR103 SFR103 CONFIDENTIEL

FR104 SFR104 AVOIR

FR108 SFR108 À CLASSER

FR113 SFR113 COMPTABILISÉ

FR115 SFR115 PHOTOCOPIE

FR116 SFR116 pour information

FR118 SFR118 SPÉCIMEN

FR126 SFR126 SAISI
 Le

FR128 SFR128 LIVRÉ

FR129 SFR129 REÇU LE

FR130 SFR130 Expres

FR131 SFR131 Facture

FR132 SFR132 Annulé

FR133 SFR133 PAYÉ-LIVRÉ

FR134 SFR134 PROFORMA

FR135 SFR135 ENVOI EN NOMBRE

FR136 SFR136 CERTIFIE CONFORME
 A L'ORIGINAL

SFR138 LETTRE
 PRIORITAIRE

SFR139 A SIGNER

GERMAN TITLES

1-Color

MAHNUNG

GE001 SGE001 MAHNUNG

GE002 SGE002 Post Express

GE003 SGE003 EILT SEHR!

GE006 SGE006 GEFAXT

GE007 SGE007 MUSTER

GE008 SGE008 GEBUCHT

GE009 SGE009 ABLAGE

GE010 SGE010 KOPIE

GE101 SGE101 Infopost

GE102 SGE102 Terminalsache

GE103 SGE103 Päckchen

GE104 SGE104 Einschreiben

GE105 SGE105 Persönlich

GE106 SGE106 BEZAHLT

GE107 SGE107 Geprüft

GE108 SGE108 Bezahlte am
 Bank | Postscheck | Kasse

GE109 SGE109 Nur zur Verrechnung

GE110 SGE110 Infobrief

GE111 SGE111 Nicht Knicken!

GE112 SGE112 DRINGEND

GE113 SGE113 Duplikat

GE114 SGE114 ERLEDIGT

GE115 SGE115 Betrag erhalten

GE116 SGE116 VERTRAULICH

ARABIC TITLES

1-Color

مضمون

AR001 SAR001 مضمون

AR002 SAR002 بريد جوي

AR003 SAR003 صورة طبق الأصل

AR004 SAR004 نموذج

AR005 SAR005 مطبوعات

AR006 SAR006 عاجل جداً

AR007 SAR007 سري للغاية

AR008 SAR008 ملغي

AR009 SAR009 مع تحيات الإدارة

AR010 SAR010 استلم بتاريخ

AR011 SAR011 طرد بريدي

AR012 SAR012 شخصي

AR013 SAR013 هام جداً

AR014 SAR014 نسخة أصلية

AR015 SAR015 نسخة ثانية

AR016 SAR016 نسخة العميل

AR017 SAR017 مسجل

AR018 SAR018 مجاز للدفع

AR019 SAR019 خالص

AR020 SAR020 مدفوع

AR021 SAR021 جيد

AR022 SAR022 جيد جداً

AR023 SAR023 ممتاز

AR024 SAR024 وفق الله تعالى

VIETNAMESE TITLES

1-Color

ĐÃ THU TIỀN

VI001 SVI001 KHẨN

VI002 SVI002 ĐÃ THU TIỀN

VI003 SVI003 HỦY

VI004 SVI004 SAO Y BẢN CHÍNH

VI005 SVI005 ĐÃ FAX

VI006 SVI006 ĐÃ THANH TOÁN



D-I-Y Set

Quality instant stamps that help to create your own texts whenever you need it. Available in Printers and Essential stamps for office use, and Handy Stamp type for mobility.

PAT. NO.: US 7, 011, 024 B1



Various Handle Sets

Shiny D.I.Y. Set features text-changeable platen(s) with a self-inking stamp which customers can choose from a selection of Shiny's Printer Line, Essential Line, and Handy Stamp for different uses.

Various Sizes and Languages

Rubber type plates are available in various sizes and languages for different needs and markets.

Simple and Convenient

D.I.Y. Set allows users to own a stamp they require whenever they need it.

Extra Removable Platens

Extra removable platens are also available for customers to keep and change the frequent use texts on selected models: S-883, S-884, S-885, S-8833, R-5842, and S-600.



S-882

B.H. PLUMBERS
HENRY STERN
2861 6261828

Insert up to 3 lines of texts.

S-882	
SIZE OF IMPRINT	14 x 38 mm
SPARE PAD	S-852-7 
PACKING	
COLOR	White

CONTAINS	
Printing stamp	1
Rubber type plate	1
Stamp pad	1
Tweezers	1



RUBBER TYPE	
4mm - 256 characters	



S-883

CABLE LOCATOR
MODEL:CP2362
INSPECTED:12 MAY 2022
BY J. DOWLING

Insert up to 4 lines of texts.

S-883	
SIZE OF IMPRINT	18 x 47 mm
SPARE PAD	S-853-7 
PACKING	
COLOR	White

CONTAINS	
Printing stamp	1
Rubber type plate	2
Removable platen	2
Stamp pad	1
Tweezers	1

RUBBER TYPE	
3mm - 328 characters	
4mm - 256 characters	



S-884

TO: CHRIS GORTON
J.B. LTD.
16A, PARKLAND
26 VICTORIA ROAD,
SYDNEY

Insert up to 5 lines of texts.

S-884	
SIZE OF IMPRINT	22 x 58 mm
SPARE PAD	S-854-7 
PACKING	
COLOR	White

CONTAINS	
Printing stamp	1
Rubber type plate	2
Removable platen	2
Stamp pad	1
Tweezers	1



RUBBER TYPE	
3mm - 328 characters	
4mm - 256 characters	



S-885

THE EYE CARE CENTER
MONDAY TO FRIDAY
OPEN 0800 CLOSE 1800
 302 369 6122
Fax: 302 369 6129
APP@THEEYECARECENTER.COM

Insert up to 6 lines of texts.

S-885	
SIZE OF IMPRINT	25 x 70 mm
SPARE PAD	S-855-7 
PACKING	
COLOR	White

CONTAINS	
Printing stamp	1
Rubber type plate	2
Removable platen	2
Stamp pad	1
Tweezers	1

RUBBER TYPE	
3mm - 328 characters	
4mm - 256 characters	



S-772

SIMPSON BOOKSTORE
71 HIGH STREET,
HONG KONG 22188
SALES@SIMPSON.com

Insert up to 4 lines of texts.

S-772 <small>NEW!</small>	
SIZE OF IMPRINT	14 x 38 mm
SPARE PAD	S-1722-7
PACKING	
COLOR	Aquamarine

CONTAINS	
Handy stamp	1
Rubber type plate	1
Stamp pad	1
Tweezers	1
RUBBER TYPE	
3.5mm - 420 characters	



S-773

MS. PATRICIA KELLY
27 JAN BR607 LHR → HK
03 FEB BR608 LHR → HK
: +44 788 0623788
e-mail: PKELLY@YAHOO.com

Insert up to 5 lines of texts.

S-773 <small>NEW!</small>	
SIZE OF IMPRINT	18 x 47 mm
SPARE PAD	S-1723-7
PACKING	
COLOR	Aquamarine

CONTAINS	
Handy stamp	1
Rubber type plate	1
Stamp pad	1
Tweezers	1
RUBBER TYPE	
3.5mm - 420 characters	



S-8831

PETER SMITH AGENCY
☎ 0114 377041

Insert up to 2 lines of texts.

S-8831	
SIZE OF IMPRINT	10 x 70 mm
SPARE PAD	S-831-7
PACKING	
COLOR	Black

CONTAINS	
Printing stamp	1
Rubber type plate	1
Stamp pad	1
Tweezers	1
RUBBER TYPE	
4mm - 256 characters	



S-8833

MOONEYS CAFE
☎ 012 455 6567
Fax: 012 455 6569
1236A LAVENDERS STREET SU 21103
WWW.MOONEYS-CAFE.COM
(FRESHLY MADE)

Insert up to 6 lines of texts.

S-8833	
SIZE OF IMPRINT	25 x 82 mm
SPARE PAD	S-833-7
PACKING	
COLOR	Black

CONTAINS	
Printing stamp	1
Rubber type plate	2
Removable platen	2
Stamp pad	1
Tweezers	1
RUBBER TYPE	
3mm - 328 characters	
4mm - 256 characters	



S-887



S-887D

Insert up to 6 lines of texts (S-887).

S-887 / S-887D	
SIZE OF IMPRINT	30 x 50 mm
SPARE PAD	S-827-7 
SPARE PAD	S-827D-7 
PACKING	
COLOR	Blue
CONTAINS	
Printing stamp	1
Rubber type plate	2
Stamp pad	1
Tweezers	1
RUBBER TYPE	
3mm - 328 characters	
4mm - 256 characters	



S-888



S-888D

Insert up to 7 lines of texts (S-888).

S-888 / S-888D	
SIZE OF IMPRINT	33 x 56 mm
SPARE PAD	S-828-7 
SPARE PAD	S-828D-7 
PACKING	
COLOR	Blue
CONTAINS	
Printing stamp	1
Rubber type plate	2
Stamp pad	1
Tweezers	1
RUBBER TYPE	
3mm - 328 characters	
4mm - 256 characters	



S-889



S-889D

Insert up to 8 lines of texts (S-889).

S-889 / S-889D	
SIZE OF IMPRINT	40 x 64 mm
SPARE PAD	S-829-7 
SPARE PAD	S-829D-7 
PACKING	
COLOR	Blue
CONTAINS	
Printing stamp	1
Rubber type plate	2
Stamp pad	1
Tweezers	1
RUBBER TYPE	
3mm - 328 characters	
4mm - 256 characters	



S-8830

CROMWELL
HEALTH & FITNESS
ERIC DAVID (COACH)
☎ 01223 245200

CROM
INFO@CRO

29 JUN 2022

S-8830D

Insert up to 8 lines of texts (S-8830).

S-8830 / S-8830D	
SIZE OF IMPRINT	38 x 75 mm
SPARE PAD	S-830-7
SPARE PAD	S-830D-7
PACKING	
COLOR	Blue
CONTAINS	
Printing stamp	1
Rubber type plate	2
Stamp pad	1
Tweezers	1
RUBBER TYPE	
3mm - 328 characters	
4mm - 256 characters	



S-5815

PETER
SMITH
AGENCY
(1976)

Insert up to 4 lines of texts (S-5815).

S-5815	
SIZE OF IMPRINT	15 x 15 mm
SPARE PAD	S-515-7
PACKING	
COLOR	Black
CONTAINS	
Printing stamp	1
Rubber type plate	1
Stamp pad	2
Tweezers	1
RUBBER TYPE	
4mm - 256 characters	



3 in one

3 different removable die platens are included



A



B



C

R-5842	
SIZE OF IMPRINT	∅ 42 mm
SPARE PAD	R-542-7
PACKING	
COLOR	Black
CONTAINS	
Printing stamp	1
Rubber type plate	1
Removable die platen	3
Stamp pad	1
Tweezers	1
Bottom cover	1
RUBBER TYPE	
3mm - 328 characters	





Option

Three different layouts to your choice.



A



C



B

EL-442	
SIZE OF IMPRINT	Ø 42 mm
SPARE PAD	Elite-42-7
PACKING	
COLOR	Ruby / Aquamarine

CONTAINS	
Printing stamp	1
Rubber type plate	1
Stamp pad	1
Tweezers	1
RUBBER TYPE	
3mm - 328 characters	



S-420



Insert up to 5 lines of texts.

S-420	
SIZE OF IMPRINT	24 x 41 mm
SPARE PAD	S-400-7B
PACKING	
COLOR	Blue

CONTAINS	
Printing stamp	1
Rubber type plate	1
Stamp pad	1
Tweezers	1
RUBBER TYPE	
4mm - 256 characters	



S-421



Insert up to 2 lines of texts.

S-421	
SIZE OF IMPRINT	24 x 41 mm
SPARE PAD	S-400-7D
PACKING	
COLOR	Blue

CONTAINS	
Printing stamp	1
Rubber type plate	1
Stamp pad	1
Tweezers	1
RUBBER TYPE	
4mm - 256 characters	



E-920



E-920D

Insert up to 5 lines of texts (E-920).

E-920 / E-920D	
SIZE OF IMPRINT	24 x 41 mm
SPARE PAD	900-7 
SPARE PAD	910-7 
PACKING	
CONTAINS	
Essential stamp	1
Rubber type plate	1
Stamp pad	1
Tweezers	1
RUBBER TYPE	
4mm - 256 characters	





E-923



E-923D

Insert up to 6 lines of texts (E-923).

E-923 / E-923D	
SIZE OF IMPRINT	30 x 50 mm
SPARE PAD	903-7 
SPARE PAD	913-7 
PACKING	
CONTAINS	
Essential stamp	1
Rubber type plate	2
Stamp pad	1
Tweezers	1
RUBBER TYPE	
3mm - 328 characters	
4mm - 256 characters	





E-927



E-927D

Insert up to 9 lines of texts (E-927).

E-927 / E-927D	
SIZE OF IMPRINT	40 x 60 mm
SPARE PAD	907-7 
SPARE PAD	917-7 
PACKING	
CONTAINS	
Essential stamp	1
Rubber type plate	2
Stamp pad	1
Tweezers	1
RUBBER TYPE	
3mm - 328 characters	
4mm - 256 characters	



H-6206

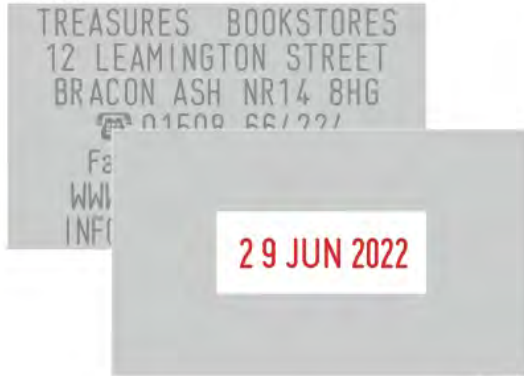

Insert up to 7 lines of texts (H-6206).

H-6216

H-6206 / H-6216	
SIZE OF IMPRINT	33 x 56 mm
SPARE PAD	906-7 
SPARE PAD	916-7 
PACKING	
CONTAINS	
Heavy Duty stamp	1
Rubber type plate	2
Stamp pad	1
Tweezers	1
RUBBER TYPE	
3mm - 328 characters	
4mm - 256 characters	



H-6208

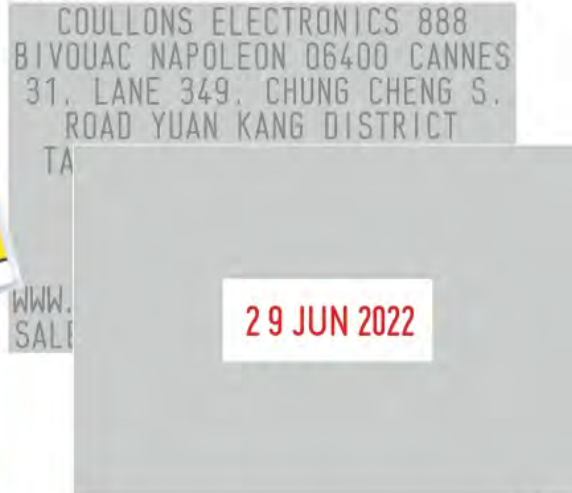

Insert up to 10 lines of texts (H-6208).

H-6218

H-6208 / H-6218	
SIZE OF IMPRINT	47 x 68 mm
SPARE PAD	908-7 
SPARE PAD	918-7 
PACKING	
CONTAINS	
Heavy Duty stamp	1
Rubber type plate	2
Stamp pad	1
Tweezers	1
RUBBER TYPE	
3mm - 328 characters	
4mm - 256 characters	



S-100 Printing kit	
PACKING	Polybagged + Exquisite
CONTAINS	
Stamp handle	1
Stamp pad	1
Platens (assorted shapes & sizes up to 5 lines)	7
Tweezers	1
RUBBER TYPE	
4mm - 405 characters	

S-200 Printing kit	
PACKING	Polybagged + Exquisite
CONTAINS	
Stamp handle	1
Stamp pad	1
Platens (assorted shapes & sizes up to 5 lines)	7
Tweezers	1
RUBBER TYPE	
4mm - 405 characters	
5mm - 196 characters	



Fungistatic
agent built-in



Die-Plate Dater



Soft Handle

The handle will not cramp your hands, and the soft material provides a comfortable feel.



Drive Wheel

The drive wheel allows users to set the date smoothly and easily.



Lock

Shiny Die-Plate Stamp features a lock that provides more convenient use of the stamp.



A-3200 / S-3200

Die-Plate Date Stamp	
A-3200	S-3200
SIZE OF IMPRINT	
1. 31 x 41 mm	<input type="checkbox"/>
2. \varnothing 41 mm	<input type="checkbox"/>
3. 31 x 45 mm	<input type="checkbox"/>
4. 55 x 55 x 55 mm	<input type="checkbox"/>
5. 32 x 32 mm	<input type="checkbox"/>
6. 32 x 38 mm	<input type="checkbox"/>
PACKING	A-3200
PACKING	S-3200
DATER BAND SIZE · 3.4 x 20 mm	
11 MAR 2022	

A-3200 ▶ Ntbac Line



Die-Plate Date Stamp	
PET-3600 / ES-3600	A-3600 / S-3600
SIZE OF IMPRINT	
1. 35 x 50 mm	<input type="checkbox"/>
2. 35 x 55 mm	<input type="checkbox"/>
3. 40 x 55 mm	<input type="checkbox"/>
4. 40 x 60 mm	<input type="checkbox"/>
5. 50 x 70 mm	<input type="checkbox"/>
6. \varnothing 51 mm	<input type="checkbox"/>
7. 51 x 51 mm	<input type="checkbox"/>
8. 44 x 67 mm	<input type="checkbox"/>
9. 25 x 55 mm	<input type="checkbox"/>
10. 35 x 45 mm	<input type="checkbox"/>
11. 35 x 60 mm	<input type="checkbox"/>
12. 35 x 70 mm	<input type="checkbox"/>
13. 40 x 70 mm	<input type="checkbox"/>
14. 45 x 65 mm	<input type="checkbox"/>
15. \varnothing 44 mm	<input type="checkbox"/>
21. 35 x 75 mm	<input type="checkbox"/>
22. 35 x 75 mm	<input type="checkbox"/>
23. 35 x 54 mm	<input type="checkbox"/>
24. 35 x 54 mm	<input type="checkbox"/>
25. 90 x 55 mm	<input type="checkbox"/>
26. 90 x 55 mm	<input type="checkbox"/>
27. 55 x 65 mm	<input type="checkbox"/>
35. 100 x 100 mm	<input type="checkbox"/>
36. 120 x 120 mm	<input type="checkbox"/>
PACKING	PET / ES / A-3600
PACKING	S-3600
DATER BAND SIZE · 7 x 30 mm	
29 JUN 2022	

A-3600 ▶ Ntbac Line
 PET-3600 ▶ ECO line
 ES-3600 ▶ ECO line



A-3600 / S-3600



S-3212

FAXED
PAID
ENTERED
DESPATCHED

Available with your own message

U.S.A. BANK
CASHIER



S-3224

Time & Date Stamp	
S-3212 / S-3224	
PACKING	

Note: The die thickness of the S-3212/S-3224 stamp must be 2.4~2.5mm.

2-color ink pad NO. S-3230 is for S-3212 and S-3224



S-3612

FAXED
PAID
ENTERED

Available with your own message

SHINY STAMP
CO., LTD.



S-3624

Time & Date Stamp	
S-3612 / S-3624	
PACKING	

Note: The die thickness of the S-3612/S-3624 stamp must be 2.6~2.7mm.





Time Stamp	
NO.2 (12-HOUR)	
PACKING	





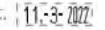

S-1000

S-1000 Die-Plate Date Stamp	
SIZE OF IMPRINT	
1. \varnothing 13 mm	<input type="radio"/>
2. \varnothing 16 mm	<input type="radio"/>
3. \varnothing 19 mm	<input checked="" type="radio"/>
4. \varnothing 21 mm	<input type="radio"/>
5. 16 x 16 mm	<input type="checkbox"/>
6. 19 x 19 mm	<input type="checkbox"/>
7. 21 x 21 mm	<input type="checkbox"/>
PACKING 	
DATER BAND SIZE \cdot 2.9 x 10 mm	
a.  b.  c. 	





S-1200

S-1200 Die-Plate Date Stamp	
SIZE OF IMPRINT	
1. \varnothing 22 mm	<input type="radio"/>
2. \varnothing 25 mm	<input type="radio"/>
3. \varnothing 28 mm	<input type="radio"/>
4. 22 x 22 mm	<input type="checkbox"/>
5. 25 x 25 mm	<input checked="" type="checkbox"/>
6. 28 x 28 mm	<input type="checkbox"/>
7. 23 x 34 mm	<input type="checkbox"/>
PACKING 	
DATER BAND SIZE \cdot 5.6 x 18 mm	
	



S-1500

S-1500 Die-Plate Date Stamp	
SIZE OF IMPRINT	
1. \varnothing 31 mm	<input type="radio"/>
2. \varnothing 34 mm	<input type="radio"/>
3. \varnothing 37 mm	<input type="radio"/>
4. \varnothing 40 mm	<input type="radio"/>
5. \varnothing 42 mm	<input type="radio"/>
6. \varnothing 46 mm	<input type="radio"/>
7. 31 x 31 mm	<input type="checkbox"/>
8. 34 x 34 mm	<input type="checkbox"/>
9. 37 x 37 mm	<input type="checkbox"/>
10. 40 x 40 mm	<input type="checkbox"/>
11. 42 x 42 mm	<input type="checkbox"/>
12. 34 x 50 mm	<input type="checkbox"/>
13. 32 x 47 mm	<input type="checkbox"/>
14. 29 x 41 mm	<input type="checkbox"/>
15. 34 x 50 mm	<input checked="" type="checkbox"/>
16. 32 x 47 mm	<input type="checkbox"/>
17. 29 x 41 mm	<input type="checkbox"/>
18. 45 x 45 x 45 mm	<input type="checkbox"/>
PACKING 	
DATER BAND SIZE \cdot 7 x 24 mm	
	



Date Stamp	
ENGLISH LAYOUT	
D-5	29 JUN 2022
D-4	29 JUN 2022
D-3	29 JUN 2022
PACKING	



Number Stamp	
PACKING	

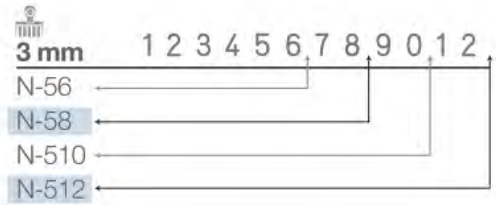

Special characters:

N° / . / % Kg / . /	N° / / . / . / % Kg / . /	N° / / / . / . / % Kg / . /	N° / / / . / . / % Kg / . /
€ - - - 1/2 %	€ - - - F - 1/2 %	€ - - - - F - 1/2 %	€ - - - - F - 1/2 %
# X . ø % lb.	# . . X ø X % lb.	# . . . X ø X % lb.	# . . . X ø X % lb.
\$ St.	\$ St.	\$ St.	\$ St.
N-56	N-58	N-510	N-512

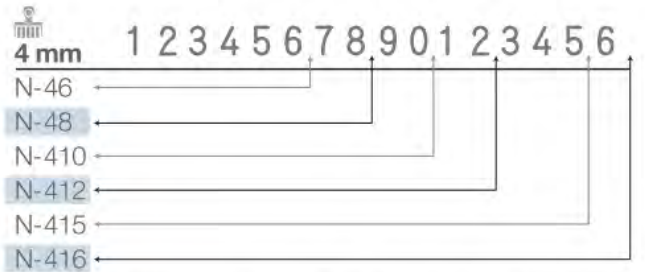

Special characters:

N° / . / % Kg / . /	N° / / . / . / % Kg / . /	N° / / / . / . / % Kg / . /	N° / / / . / . / % Kg / . /	N° / / / . / . / % Kg / . /	N° / / / . / . / % Kg / . /
€ - - - 1/2 %	€ - - - F - 1/2 %	€ - - - - F - 1/2 %	€ - - - - F - 1/2 %	€ - - - - F - 1/2 %	€ - - - - F - 1/2 %
# X . ø % lb.	# . . X ø X % lb.	# . . . X ø X % lb.	# . . . X ø X % lb.	# . . . X ø X % lb.	# . . . X ø X % lb.
\$ St.	\$ St.	\$ St.	\$ St.	\$ St.	\$ St.
N-46	N-48	N-410	N-412	N-415	N-416

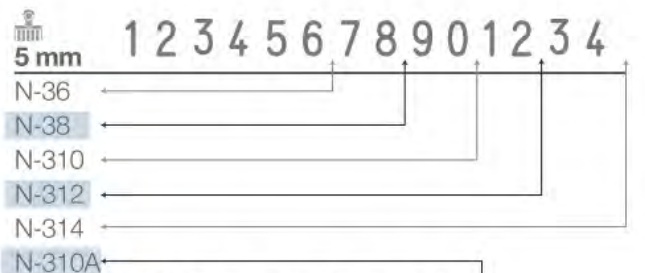

A N 1 2 3 4 5 6 7 8

Special characters:

N° / . / % Kg / . /	N° / / . / . / % Kg / . /	N° / / / . / . / % Kg / . /	N° / / / . / . / % Kg / . /	N° / / / . / . / % Kg / . /	N° / / / . / . / % Kg / . /
€ - - - 1/2 %	€ - - - F - 1/2 %	€ - - - - F - 1/2 %	€ - - - - F - 1/2 %	€ - - - - F - 1/2 %	€ - - - - F - 1/2 %
# X . ø % lb.	# . . X ø X % lb.	# . . . X ø X % lb.	# . . . X ø X % lb.	# . . . X ø X % lb.	# . . . X ø X % lb.
\$ St.	\$ St.	\$ St.	\$ St.	\$ St.	\$ St.
N-36	N-38	N-310	N-312	N-314	N-310A



Number Stamp
PACKING

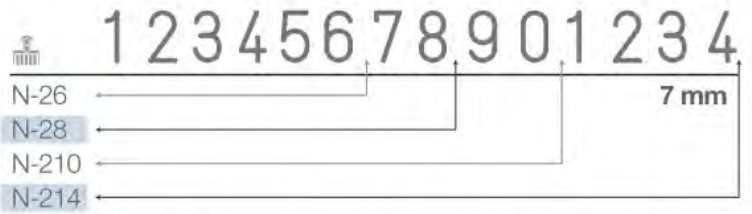

Special characters:

N-26	N-28	N-210	N-214
° / . % Kg € - - - ½ % # X . φ % lb.	° / . . % Kg € - - - F - ½ % # . X φ X % lb.	° / / / . . % Kg € - - - - F - ½ % # . . . X φ X % lb.	° / / / / . . % Kg / / / € - - - - - F - ½ % - F - # X φ X % lb . φ . .
\$ \$	\$ \$	\$ \$	\$ \$

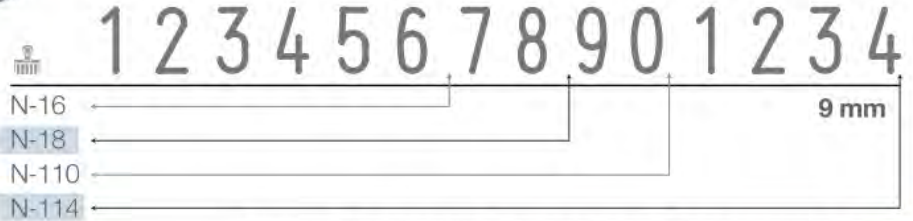

Special characters:

N-16	N-18	N-110	N-114
° / . % Kg € - - - ½ % # X . φ % lb.	° / / . . % Kg € - - - F - ½ % # . X φ X % lb.	° / / / . . % Kg € - - - - F - ½ % # . . . X φ X % lb.	° / / / / . . % Kg / / / € - - - - - F - ½ % - F - # X φ X % lb . φ . .
\$ \$	\$ \$	\$ \$	\$ \$

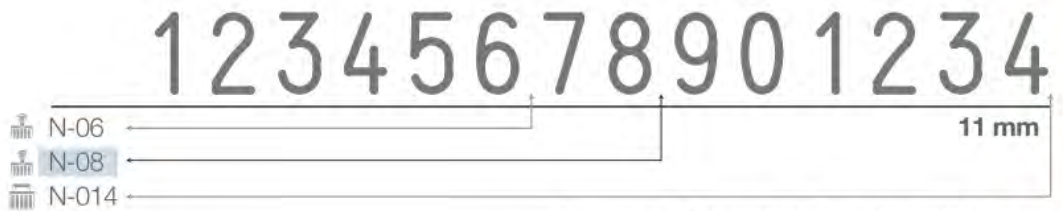

Special characters:

N-06	N-08	N-014
° / . % Kg € - - - ½ % # X . φ % lb.	° / / . . % Kg € - - - F - ½ % # . X φ X % lb.	° / / / . . % Kg / / / € - - - - F - ½ % - F - # . . . X φ X % lb . φ . .
\$ \$	\$ \$	\$ \$

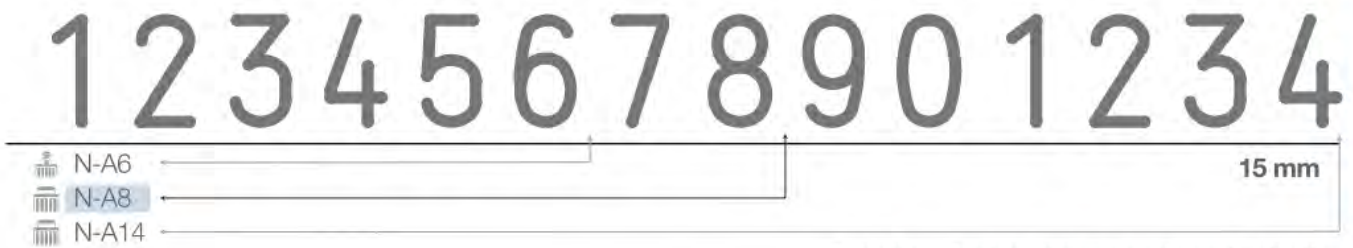

Special characters:

N-A6	N-A8	N-A14
° / . % Kg € - - - ½ % # X . φ % lb.	° / / . . % Kg € - - - F - ½ % # . X φ X % lb.	° / / / . . % Kg / / / € - - - - F - ½ % - F - # . . . X φ X % lb . φ . .
\$ \$	\$ \$	\$ \$

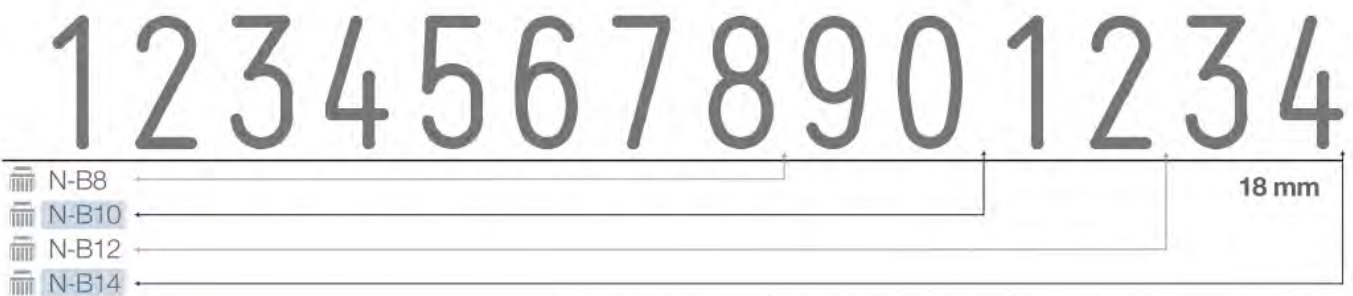

Special characters:

N-B8	N-B10	N-B12	N-B14
° / / . . % Kg € - - - F - ½ % # . X φ X % lb.	° / / / . . % Kg € - - - - F - ½ % # . . X φ X % lb.	° / / / / . . % Kg / / / € - - - - - F - ½ % - F - # X φ X % lb . φ . .	° / / / / . . % Kg / / / € - - - - - F - ½ % - F - # X φ X % lb . φ . .
\$ \$	\$ \$	\$ \$	\$ \$



ENGLISH LAYOUT S-66



50% scale



S-67



S-68

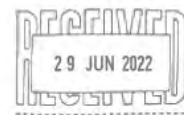

S-69

Flatband Die-Plate Dater

LAYOUT	
GERMAN - THAI ITALIAN - SPANISH	
PACKING	



ENGLISH LAYOUT S-70

PAID 29 JUN 2022

ANSWERED · Backordered · CANCELLED
BILLED · CHARGED · CHECKED · DELIVERED
ENTERED · PAID · RECEIVED · SHIPPED

Dial-a-Phrase Dater

LAYOUT	
GERMAN - FRENCH ITALIAN - SPANISH	
PACKING	



ENGLISH LAYOUT S-72

VIA AIR MAIL

AIR PARCEL POST · DO NOT BEND
FIRST CLASS MAIL · FOR DEPOSIT ONLY
HAND STAMP ONLY · PARCEL POST
PLEASE REMIT · PRINTED MATTER
REGISTERED · SPECIAL DELIVERY
SPECIAL HANDLING · VIA AIR MAIL

Dial-a-Phrase Stamp

LAYOUT	
S-72 → GERMAN - FRENCH ITALIAN - SPANISH	
PACKING	

ENGLISH LAYOUT S-76

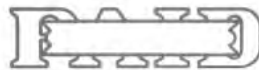

- | | | |
|-------------------|---------------------------|----------------|
| 1. A/C PAYEE ONLY | 5. DUPLICATE | 9. |
| 2. BY HAND | 6. FAX IN..... | 10. |
| 3. CANCELLED | 7. FAX OUT..... | 11. REGISTERED |
| 4. COPY | 8. PRIVATE & CONFIDENTIAL | 12. URGENT |

ENGLISH LAYOUT S-78



- | | | |
|-------------------------|--------------------------------|-------------------------|
| 1. APPROVED FOR PAYMENT | 5. REJECTED | 9. THIS COPY IS FOR |
| 2. | 6. PAID..... | 10. INCOMING |
| 3. CREDIT NOTE | 7. THIS ACCOUNT IS NOW OVERDUE | 11. OUTGOING |
| 4. ACCEPTED | 8. THIS COPY IS FOR | 12. CERTIFIED TRUE COPY |



Stamp Rack						
ITEM NO	FOR...	STAMPS	ITEM NO	FOR...	STAMPS	PACKING
S-966		6	S-9414		6 + 8	
S-968		8	S-9416		6 + 10	
S-9610		10				

S5-Kit Versatile Stamp Pad Kit



Premium Ink

Felt Pad

For special application





Stamp Pad

60

Stamp Pad

Versatile Stamp Pad Kit

PACKING · POLYBAGGED + 

Color	Item No.	Pad Size	Ink Capacity
 White	S5-Kit	79 x 155 mm	28 ml
 Black			
 Red			
 Blue			



- Seeing that the Premium Ink is volatile, only refill the Stamp Pad (Felt) with adequate volume and stay in a ventilated environment when using it.
- Only use rubber die with Premium Ink, but not photopolymer.



Genuine ink on appropriate applications guarantees long term satisfactions.

Stamp Pad



PACKING · POLYBAGGED +

Pad Color	High-Density Foam Series		Felt Series		Pad Size	
Black						
Red	S-1HF	SP-1HF	S-1F	SP-1F	45 x 65	mm (1-3/4" x 2-9/16")
Blue	S-2HF	SP-2HF	S-2F	SP-2F	57 x 88	mm (2-1/4" x 3-1/2")
Violet	S-3HF	SP-3HF	S-3F	SP-3F	70 x 110	mm (2-3/4" x 4-3/8")
Green	S-4HF		S-4F		128 x 178	mm (5" x 7")
Without ink	S-5HF		S-5F		79 x 155	mm (3-1/8" x 6-1/8")

To refill the Stamp Pad, always use SHINY Supreme Ink for best imprint results.



S-1F / S-2F / S-3F



SP-1F / SP-2F / SP-3F



S-4F / S-5F



Thumb Print Pad



PACKING · POLYBAGGED +

Color	Item No.	Pad Size	Please Note
Black	SM-1	45 x 65 mm	To refill the Thumb Print Pad, always use SHINY Eminent Ink. (E-161-9 Black, E-161-2 Red, or E-161-3 Blue) for best imprint results.
Red	SM-2	∅ 40 mm	
Blue			

Thumb Print Pad is specially designed for insurance, financial services, and law enforcement. Unique waterproof ink that won't fade away, provides quality thumb print impressions.



SM-2



SM-1

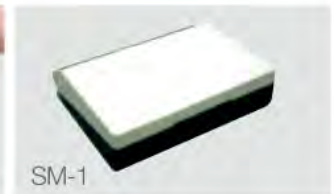

Release Agent / for Personal Seal



PACKING ·

Item No.	Pad Size	Usage
WR-1	∅ 40 mm	The release agent will make the separation of wax sealing much smoother.



1



2



3



When used on a self-inking stamp, make sure the ink pad is compatible with oil-based ink.



Supreme Ink For Self-inking Stamp

PACKING

Color	Item No.				
	28 ml	60 ml	60 ml	500 ml	1,000 ml
Black	S-61	S-81	S-81B	S-61-0.5K	S-61-1K
Red	S-62	S-82	S-82B	S-62-0.5K	S-62-1K
Blue	S-63	S-83	S-83B	S-63-0.5K	S-63-1K
Violet	S-64	S-84	S-84B	S-64-0.5K	S-64-1K
Green	S-65	S-85	S-85B	S-65-0.5K	S-65-1K
Bordeaux	SR-1			SR-1-0.5K	SR-1-1K
Brown	SR-2			SR-2-0.5K	SR-2-1K
Yellow	SR-3			SR-3-0.5K	SR-3-1K
Mint	SR-4			SR-4-0.5K	SR-4-1K
Orange	SR-5			SR-5-0.5K	SR-5-1K
Pink	SR-6			SR-6-0.5K	SR-6-1K
Turquoise	SR-7			SR-7-0.5K	SR-7-1K



Non-Porous Ink



PACKING · POLYBAGGED +

Color	Item No.	Capacity	Please Note
	NP-6□	15 ml	<ul style="list-style-type: none"> The Non-Porous Ink can be stamped on any smooth surface, and it works on self-inking stamps as well as stamp pads. The special ingredient requires good match with felt pad material. Only use rubber die with Non-Porous Ink, but not photopolymer. Special felt replacement pad can be ordered from Shiny.
Black	NP-61		
Red	NP-62		
Blue	NP-63		
Violet	NP-64		
Green	NP-65		



Press
↓ ↓ ↓



To extend the usage of replacement pad with special ingredient ink, please separate the die plate from replacement pad on 1st lock after use.



Pre-Inked Stamp Ink



PACKING ·

Color	Item No.	Capacity
Red	SO-62	10 ml
Blue	SO-63	

Please Note

The Pre-Inked Stamp Ink is for OA Pre-inked Stamp use only.



Special Ink

□□-□ / 28 ml

□□-□-1K / 1,000 ml

PACKING ·

Series	Color	Item No.	Stamp Pad	Self-Inking Stamp	QR Code
Invisible Ink	Invisible	SU-0 SU-0-1K			
Textile	Black	ST-1 ST-1-1K	Felt	Felt	
	Blue	ST-3 ST-3-1K			
Numbering Machine	Black	SN-1			
	Red	SN-2			

Premium Ink



PACKING · POLYBAGGED +

Color	Item No.	Item No.	Capacity
White	SI-60 SI-70B	SI-6□	15 ml
Black	SI-61 SI-71B	SI-7□B	60 ml
Red	SI-62 SI-72B	SI-6□-0.5K	500 ml
Blue	SI-63 SI-73B	SI-6□-1K	1,000 ml



Seeing that the Premium Ink is volatile, only refill the Stamp Pad (Felt) with adequate volume and stay in a ventilated environment when using it.

Only use rubber die with Premium Ink, but not photopolymer.

The Premium Ink is formulated for the materials listed:

Results ● Very Good ▲ Good

● Glass	● Wood	● Aluminum
● Corrugated paper	● Cellophane	● Stainless steel
▲ Textile	▲ Acrylic	▲ Rubber
▲ Leather	▲ PVC	▲ Copper
		▲ Plastic
		▲ China

SLR-300 Laser Rubber Sheet

Thickness: 2.3 mm / 2.8 mm



SLR-300 Hardness: 60-62Sha

- No odor when engraving
- Complies REACH and RoHS regulations
- Suitable for both water and oil based inks
- Up to 55% faster than other odorless rubbers
- Sharp and rigid

• Sizes: 220 x 307 mm • Color: Gray / Red

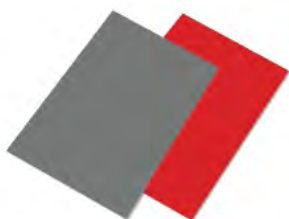

SLR-301 (SOFT) Hardness: 52Sha

- No odor when engraving
- Up to 65% faster than other odorless rubbers
- Complies REACH and RoHS regulations
- Suitable for both water and oil based inks
- Sharp and rigid

• Sizes: 220 x 307 mm • Color: Gray / Red



SLR-302 (ECO) Hardness: 52Sha

- Natural laser rubber in eco-green
- No odor when engraving
- Up to 65% faster than other odorless rubbers
- Complies REACH and RoHS regulations
- Suitable for both water and oil based inks
- Sharp and rigid

• Sizes: 220 x 307 mm • Color: Green

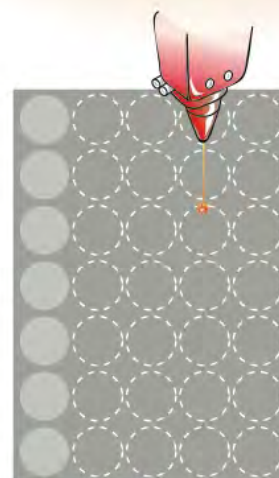

Each SLR-300 can produce approximately 35 rubber dies for R-542 (Ø42 mm)



No odor when engraving



Compatible with special inks



Sharp and rigid

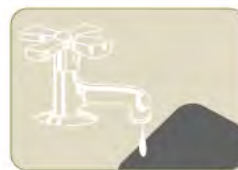

After engraving, lightly brush with soap or cleansing liquid to clean up the dust and dry with compressed air.

SLR-200 Laser Rubber Sheet (Standard)

Thickness: 2.3 mm / 2.8 mm



SLR-200

- Sharp and rigid
 - Compatible with oil-based ink
 - Easy cleaning
- Sizes: 210 x 297 mm • Color: Red / Gray

Replacement Ink Pad

PRINTER LINE

Stamp	Pad No.	Pad Color
S-851	S-851-7	Black, Red, Blue, Purple, Green, White
S-852	S-852-7	Black, Red, Blue, Purple, Green, White
S-853	S-853-7	Black, Red, Blue, Purple, Green, White
S-854	S-854-7	Black, Red, Blue, Purple, Green, White
S-855	S-855-7	Black, Red, Blue, Purple, Green, White
The above replacement pads are also compatible with the following printers; S1821~S1825; S-841~S-845.		
S-814	S-814-7	Black, Red, Blue, Purple, Green, White
S1821 A/S-841	S1821-7	Black, Red, Blue, Purple, Green, White
S-841L	S821L-7	Black, Red, Blue, Purple, Green, White
S1822 A/S-842 PET/ES-842	S1822-7	Black, Red, Blue, Purple, Green, White
S1823 A/S-843 PET/ES-843	S1823-7	Black, Red, Blue, Purple, Green, White
S1824 A/S-844 PET/ES-844	S1824-7	Black, Red, Blue, Purple, Green, White
S1825 A/S-845	S1825-7	Black, Red, Blue, Purple, Green, White
A/S-846 PET/ES-846	S-846-7	Black, Red, Blue, Purple, Green, White
S-826	S-400-7B	Black, Red, Blue, Purple, Green, White
S-827	S-827-7	Black, Red, Blue, Purple, Green, White
S-828	S-828-7	Black, Red, Blue, Purple, Green, White
S-829	S-829-7	Black, Red, Blue, Purple, Green, White
S-830 S-830DD S-830DR S-830DL S-830NN S-830NR S-830NL	S-830-7	Black, Red, Blue, Purple, Green, White
S-308	S-308-7	Black, Red, Blue, Purple, Green, White
S-310	S-311-7	Black, Red, Blue, Purple, Green, White
S-831	S-831-7	Black, Red, Blue, Purple, Green, White
S-832	S-832-7	Black, Red, Blue, Purple, Green, White
S-833	S-833-7	Black, Red, Blue, Purple, Green, White
S-834	S-834-7	Black, Red, Blue, Purple, Green, White
S-835 S-835D	S-835-7	Black, Red, Blue, Purple, Green, White
S-836	S-836-7	Black, Red, Blue, Purple, Green, White
S-837	S-837-7	Black, Red, Blue, Purple, Green, White
S-510	S-510-7	Black, Red, Blue, Purple, Green, White
S-815	S-815-7	Black, Red, Blue, Purple, Green, White
S-515	S-515-7	Black, Red, Blue, Purple, Green, White
S-520	S-520-7	Black, Red, Blue, Purple, Green, White
S-524 S-524D	S-524-7	Black, Red, Blue, Purple, Green, White
S-530 S-530D	S-530-7	Black, Red, Blue, Purple, Green, White
S-530F	S-530-7F	Black + Red, Blue + Purple
S-538	S-538-7	Black, Red, Blue, Purple, Green, White
S-542	S-542-7	Black, Red, Blue, Purple, Green, White
S-542F	S-542-7F	Black + Red, Blue + Purple
S-820	S-820-7	Black, Red, Blue, Purple, Green, White

PRINTER LINE

Stamp	Pad No.	Pad Color
S-826D	S-400-7C	Black + Red, Blue + Purple
S-827D	S-827D-7	Black + Red, Blue + Purple
S-828D	S-828D-7	Black + Red, Blue + Purple
S-829D	S-829D-7	Black + Red, Blue + Purple
S-830D	S-830D-7	Black + Red, Blue + Purple
S-834D	S-834D-7	Black + Red, Blue + Purple
S-836D	S-836D-7	Black + Red, Blue + Purple
S-837D	S-837D-7	Black + Red, Blue + Purple
S-538D	S-538D-7	Black + Red, Blue + Purple
S-542D	S-542D-7	Black + Red, Blue + Purple

DATE PRINTER

Stamp	Pad No.	Pad Color
A/S-300 PET/ES-300 S-304 A/S-309 PET/ES-309	S-300-7	Black, Red, Blue, Purple, Green, White
S-311~S-314 S-310A~S-310D	S-311-7	Black, Red, Blue, Purple, Green, White

DATE PRINTER

Stamp	Pad No.	Pad Color
S-310A ? S-310D	S-311-7A	Black, Red, Blue, Purple, Green, White

DATE PRINTER

Stamp	Pad No.	Pad Color
S-312 S-314	S-311-7B	Black, Red, Blue, Purple, Green, White

DATE PRINTER

Stamp	Pad No.	Pad Color
A/S-400 PET/ES-400 A/S-409 PET/ES-409 A/S-414 PET/ES-414 S-449	S-400-7	Black, Red, Blue, Purple, Green, White

DATE PRINTER

Stamp	Pad No.	Pad Color
S-303 S-302D	S-303-7	Black + Red, Blue + Purple

DATE PRINTER

Stamp	Pad No.	Pad Color
S-401 ? S-408 S-410	S-400-7D	Black + Red, Blue + Purple

PRINTER LINE

Stamp	Pad No.	Pad Color 
S-822A	S-822-7A	
S-823A	S-823-7A	
S-824A	S-824-7A	
S-825A	S-825-7A	
S-827A	S-827-7A	
S-828A	S-828-7A	
S-829A	S-829-7A	
S-830A	S-830-7A	
S-833A	S-833-7A	



PRINTER LINE

Stamp	Pad No.	Pad Color 
S-822B	S-822-7B	
S-823B	S-823-7B	
S-824B	S-824-7B	
S-825B	S-825-7B	
S-830B	S-830-7B	
S-832B	S-832-7B	
S-833B	S-833-7B	





PRINTER LINE

Stamp	Pad No.	Pad Color 
S-827C	S-827-7C	
S-828C	S-828-7C	
S-829C	S-829-7C	
S-830C	S-830-7C	
S-542C	S-542-7C	

PRINTER LINE

Stamp	Pad No.	Pad Color 
S-833D	S-833-7D	



PRINTER LINE

Stamp	Pad No.	Pad Color 
S-828E	S-828-7E	
S-829E	S-829-7E	
S-834E	S-834-7E	



PRINTER LINE

Stamp	Pad No.	Pad Color 
S-821	S-821-7	
S-822	S-822-7	
S-823	S-823-7	
S-824	S-824-7	
S-825	S-825-7	



PRINTER LINE

Stamp	Pad No.	Pad Color 
TRI-45	TRI-45-7	
TRI-45D		

PRINTER LINE

Stamp	Pad No.	Pad Color 
O-3045	O-3045-7	
O-3555	O-3555-7	



PRINTER LINE

Stamp	Pad No.	Pad Color 
O-3045D	O-3045D-7	
O-3555D	O-3555D-7	

PRINTER LINE

Stamp	Pad No.	Pad Color 
R-512	R-512-7	
R-517	R-517-7	
R-517D	R-517D-7	
R-520	R-520-7	
R-524	R-524-7	
R-524D		
R-532	R-532-7	
R-538	R-538-7	
R-542	R-542-7	
R-546	R-546-7	
R-552	R-552-7	







PRINTER LINE

Stamp	Pad No.	Pad Color 
R-532F	R-532-7F	
R-542F	R-542-7F	

PRINTER LINE

Stamp	Pad No.	Pad Color 
R-532D	R-532D-7	
R-538D	R-538D-7	
R-542D	R-542D-7	
R-542D-T12		
R-542D-T24		
R-546D	R-546D-7	
R-552D	R-552D-7	

ESSENTIAL EO STAMP (DRY PAD ONLY)

Stamp	Pad No.	Pad Color 
EO-910	900EO-7	
EO-913	903EO-7	
EO-915	905EO-7	
EO-914	906EO-7	
EO-916		
EO-917	907EO-7	
EO-918	908EO-7	

ESSENTIAL LINE / HEAVY DUTY / HEAVY METAL

Stamp	Pad No.	Pad Color
H-6100 · E-910 · HM-6100 H-61008 · E-91008 · HM-61008 H-6446/PL · E-946/PL · HM-6446/PL	910-7	
H-6101 · H-61106 · HM-6101 · HM-61106 · E-911	6101-7	
H-6103 · E-913 · HM-6103 H-61306 · E-91306 · HM-61306 H-61308 · E-91308 · HM-61308	913-7	
H-6104 · E-914 · HM-6104 H-61406 · E-91406 · HM-61406 H-61408 · E-91408 · HM-61408	916-7	
H-6105 · E-915 · HM-6105 H-61506 · E-91506 · HM-61506 H-61508 · E-91508 · HM-61508	915-7	
H-6106 · E-916 · HM-6106 H-61606 · E-91606 · HM-61606 H-61608 · E-91608 · HM-61608	916-7	
H-6107 · E-917 · HM-6107 H-61706 · E-91706 · HM-61706 H-61708 · E-91708 · HM-61708	917-7	
H-6108 · E-918 · HM-6108 H-61806 · E-91806 · HM-61806 H-61808 · E-91808 · HM-61808	918-7	
H-6110 · H-6109 · H-6109-T12/T24 HM-6109 · HM-6109-T12/T24	6109-7	
HM-6114 · HM-61146 · HM-61148	6114-7	
HM-6115 · HM-61156 · HM-61158	6115-7	

ESSENTIAL LINE / HEAVY DUTY / HEAVY METAL

Stamp	Pad No.	Pad Color
H-6000 · E-900 · HM-6000 H-6440 · E-940 · HM-6440 H-6446 · E-946 · HM-6446	900-7	
H-6001 · HM-6001 · E-901	6001-7	
H-6003 · E-903 · HM-6003	903-7	
H-6004 · E-904 · HM-6004 H-6006 · E-906 · HM-6006 H-6770 · E-970 · HM-6770 H-6558 · E-958 · HM-6558 H-6510 · E-9510 · HM-6510 H-6558/PL · E-958/PL · HM-6558/PL H-6510/PL · E-9510/PL · HM-6510/PL	906-7	
H-6005 · E-905 · HM-6005	905-7	
H-6007 · E-907 · HM-6007 H-6708/PL · E-9708/PL · HM-6708/PL H-6710/PL · E-9710/PL · HM-6710/PL	907-7	
H-6008 · E-908 · HM-6008 H-6118DD · E-918DD · HM-6118DD H-6118DR · E-918DR · HM-6118DR H-6118DL · E-918DL · HM-6118DL H-6118NN · E-918NN · HM-6118NN H-6118NR · E-918NR · HM-6118NR H-6118NL · E-918NL · HM-6118NL H-6416 · E-9416 · HM-6416 H-6416/PL · E-9416/PL · HM-6416/PL H-6418 · E-9418 · HM-6418 H-6418/PL · E-9418/PL · HM-6418/PL	908-7	
H-6010 · H-6009 · HM-6009	6009-7	
HM-6014	6014-7	
HM-6015	6015-7	

STOCK OA (Self-Inking)

Stamp	Pad No.	Pad Color
S-222	S-852-7	

ELITE STAMP

Stamp	Pad No.	Pad Color
EL-42	Elite-42-7	

HANDY STAMP

Stamp	Pad No.	Pad Color
A/S-722	S-1722-7	
A/S-723	S-1723-7	
S-724	S-1724-7	
ES-722	S-722-7	
ES-723	S-723-7	
S-Q12	S-Q12-7	
S-Q17	S-Q17-7	
S-Q24	S-Q24-7	
S-Q32	S-Q32-7	
S-Q32F	S-Q32-7F	
S-Q42	S-Q42-7	
S-Q42F	S-Q42-7F	

D-I-Y SET

Stamp	Pad No.	Pad Color
S-421	S-400-7D	
S-887D	S-827D-7	
S-888D	S-828D-7	
S-889D	S-829D-7	
S-8830D	S-830D-7	
E-920D	910-7	
E-923D	913-7	
E-927D	917-7	
H-6216	916-7	
H-6218	918-7	

D-I-Y SET

Stamp	Pad No.	Pad Color
S-772 NEW!	S-1722-7	
S-773 NEW!	S-1723-7	
S-882	S-852-7	
S-883	S-853-7	
S-884	S-854-7	
S-885	S-855-7	
S-600	S-824-7	
S-420	S-400-7B	
S-887	S-827-7	
S-888	S-828-7	
S-889	S-829-7	
S-8830	S-830-7	
S-8831	S-831-7	
S-8833	S-833-7	
E-920	900-7	
E-923	903-7	
E-927	907-7	
S-800	S1823-7	
S-810	S1823-7	
H-6206	906-7	
H-6208	908-7	
S-5815	S-515-7	
R-5842	R-542-7	
EL-442	Elite-42-7	



Personal seal Wax Seal Stamp

Shiny Personal Seal Pack comes with a genuine wood handle, interchangeable die and one Waterstons high quality Scottish sealing wax stick.

Moreover, Shiny offers a selection of different changeable dies that include the plain one for your personal initials & designs.

You could add a personal flair to your letters, gift wrapping, or invitations.

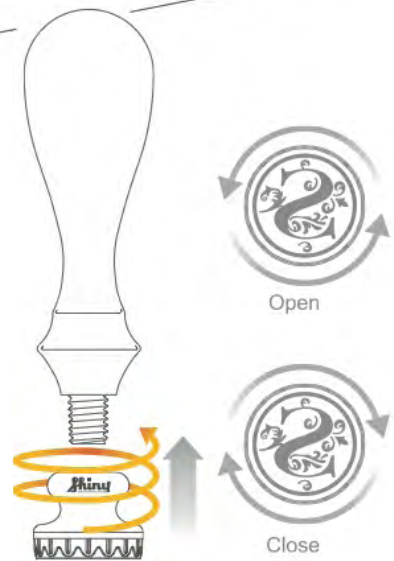

W-□□□	
SIZE OF IMPRINT	∅ 18.5 mm
SIZE OF IMPRINT	○ 18.4 x 28.4 mm
PACKING	

Blister shell package includes

Wooden handle
Interchangeable die
Red sealing wax stick

Choose the preferable pattern from one available in page P.71 i.e. W-001



WP-□□□	
SIZE OF IMPRINT	∅ 18.5 mm
SIZE OF IMPRINT	○ 18.4 x 28.4 mm
PACKING	
Blister shell package includes	
Wooden handle Interchangeable die Red sealing wax stick Release agent	
Choose the preferable pattern from one available in page P.71 i.e. WP-001	



WSP-1



WSP-2

WSP-1	
PACKING	
Spoon only	

WSP-2□□□	
PACKING	
Spoon with a bottle of preferred Sealing Wax Beads	

Choose the preferable Sealing Wax Beads from one available in page P.71 i.e. WSP-201



(3 dies package)



(Single die package)

WS-01	
PACKING	
Multiple dies package is also available	



WI-□□□	
PACKING	
Blister shell package includes	
Wax stick x 3pcs	
Option: Red, Gold, or Silver	



WB-□□□	
PACKING	
Choose the preferable Sealing Wax Beads from one available in page P.71 i.e. WB-01	



WR-1 Release Agent	
SIZE OF IMPRINT	∅ 40 mm
PACKING	



A Alphabet Series 90% scale



B Sign Series 90% scale



C Holiday Series 85% scale



WI-□□

Sealing Wax Stick



WB-□□

Sealing Wax Beads



Flash Stamp

Uses only top quality ink and flash materials, Shiny's Flash Stamps guarantee excellent impression that is superior to others.



NEW!

• Premier Line



NEW!

• Lite



• Eminent Kit

• Eminent Line



Stamp Mount



Die Box



Cover



Premier Line **NEW!**

This high quality, easy to manufacture pre-inked stamp is available in 26 mount sizes and 6 pocket style mounts

Flash

▶ Ink it

▶ Snap

- * The soft handle allows for a better grip and comfort.
- * High quality ink and cartridge materials.
- * The patented template enables easy alignment of the artwork. No trial & error and no mistakes !
- * The template also has suggested ink volume at each unit.
- * Easy to re-ink for thousands of additional impressions.



EA-055

Riverside Medical Group

EA-055	
SIZE OF IMPRINT	7 x 63 mm
DIE BOX	EA-055-6
PACKING	



EA-70

GARMAX INTERNATIONAL
54311 CADALLIC RD.
P.O. BOX 668
ABILENE, TEXAS 78960

EA-70	
SIZE OF IMPRINT	14 x 39 mm
DIE BOX	EA-70-6
PACKING	



EA-75

**PREMIUM NOTICE
ENCLOSED**

EA-75	
SIZE OF IMPRINT	15 x 46 mm
DIE BOX	EA-75-6
PACKING	



EA-105

**TAX DOCUMENTS
ENCLOSED**

EA-105	
SIZE OF IMPRINT	17 x 42 mm
DIE BOX	EA-105-6
PACKING	



EA-110

**APPLICATION
RECEIVED**

EA-110	
SIZE OF IMPRINT	17 x 57 mm
DIE BOX	EA-110-6
PACKING	



EA-115

Advanced Industrial
4564 JACKSON STREET
ELGIN, IL 60123

EA-115	
SIZE OF IMPRINT	20 x 50 mm
DIE BOX	EA-115-6
PACKING	



EA-125

Mr. & Mrs. John Smith
1234 S. Main St.
Mayville, CA 94567

EA-125	
SIZE OF IMPRINT	26 x 51 mm
DIE BOX	EA-125-6
PACKING	



EA-140

Pay To The Order of
First National Bank
For Deposit Only
Kingston Group, Inc.
963-885207411

EA-140	
SIZE OF IMPRINT	30 x 52 mm
DIE BOX	EA-140-6
PACKING	



EA-145

PROCESSED
DATE _____

EA-145	
SIZE OF IMPRINT	16 x 62 mm
DIE BOX	EA-145-6
PACKING	



EA-150

KAHULIU KOOL DOG CAFE
145 FASHION WAY
KAHULIU, HI 96732

EA-150	
SIZE OF IMPRINT	22 x 64 mm
DIE BOX	EA-150-6
PACKING	



EA-165

BEN	<input type="checkbox"/>	RAY	<input type="checkbox"/>
DONALD	<input type="checkbox"/>	SUSAN	<input type="checkbox"/>
ROSE	<input type="checkbox"/>	KINDER	<input type="checkbox"/>
HARRY	<input type="checkbox"/>	ALAN	<input type="checkbox"/>
ANITA	<input type="checkbox"/>	PETER	<input type="checkbox"/>

EA-165	
SIZE OF IMPRINT	38 x 64 mm
DIE BOX	EA-165-6
PACKING	



EA-185

PROPRIETARY INFORMATION
 To be returned to: **Webster, Rathbone & Soarns**
 and not be reproduced in any form
 without express written permission

EA-185	
SIZE OF IMPRINT	24 x 72 mm
DIE BOX	EA-185-6
PACKING	



EA-190

PAID IN FULL
 ALL RETURNS MUST BE
 ACCOMPANIED WITH A
 RECEIPT. ONLY STORE
 CREDIT WILL BE ISSUED.

EA-190	
SIZE OF IMPRINT	30 x 70 mm
DIE BOX	EA-190-6
PACKING	



EA-225

IMPORTANT!
 IF BOX OPENED DURING
 SHIPMENT-
 PLEASE CHECK
 CONTENTS CAREFULLY

EA-225	
SIZE OF IMPRINT	52 x 75 mm
DIE BOX	EA-225-6
PACKING	



EA-245



EA-245	
SIZE OF IMPRINT	38 x 83 mm
DIE BOX	EA-245-6
PACKING	



EA-265

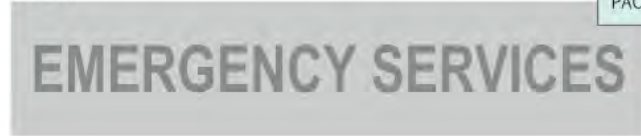

EA-265	
SIZE OF IMPRINT	18 x 85 mm
DIE BOX	EA-265-6
PACKING	



EA-275



EA-275	
SIZE OF IMPRINT	48 x 100 mm
DIE BOX	EA-275-6
PACKING	



EA-720

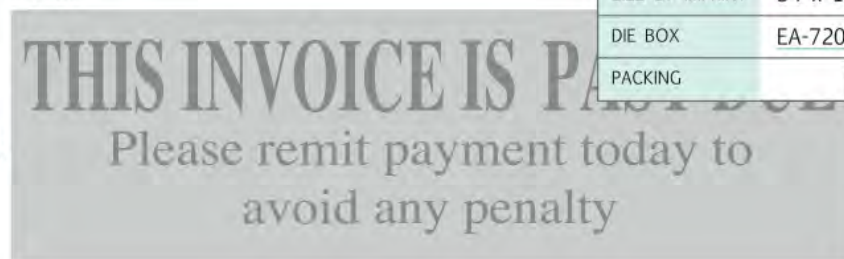

EA-720	
SIZE OF IMPRINT	34 x 112 mm
DIE BOX	EA-720-6
PACKING	



EA-750

EA-750	
SIZE OF IMPRINT	45 x 130 mm
DIE BOX	EA-750-6
PACKING	
JOB#	DEPT
CATEGORY#	COST CTR
BUDGET	OGHF:
BID AMOUNT	BLEED



EA-700

DEBT APPROVAL	
COMPANY:	VOUCHER #:
DATE:	EA-700
DATE:	
AMOUNT:	
CHECK #:	SIZE OF IMPRINT
	75 x 100 mm
	DIE BOX
	EA-700-6
	PACKING
W-9 SENT? :	



EA-800

EA-800				
SIZE OF IMPRINT				
95 x 130 mm				
DIE BOX				
EA-800-6				
PACKING				
Tax ID #				
Account Number	Cost Center	Free Form/Description	Code	Amount
Authorized by:		Approval Code:	Date:	
Authorized by:		Approval Code:	Date:	



EA-305



EA-305	
SIZE OF IMPRINT	Ø 14 mm
DIE BOX	EA-305-6
PACKING	



EA-325



EA-325	
SIZE OF IMPRINT	Ø 19 mm
DIE BOX	EA-325-6
PACKING	



EA-495



EA-495	
SIZE OF IMPRINT	Ø 33 mm
DIE BOX	EA-495-6
PACKING	



EA-535



EA-535	
SIZE OF IMPRINT	Ø 42 mm
DIE BOX	EA-535-6
PACKING	



EA-655



EA-655	
SIZE OF IMPRINT	Ø 52 mm
DIE BOX	EA-655-6
PACKING	



EA-305



EA-305	
SIZE OF IMPRINT	Ø 14 mm
DIE BOX	EA-305-6
PACKING	



EA-325



EA-325	
SIZE OF IMPRINT	Ø 19 mm
DIE BOX	EA-325-6
PACKING	



EA-495



EA-495	
SIZE OF IMPRINT	Ø 33 mm
DIE BOX	EA-495-6
PACKING	



EA-535



EA-535	
SIZE OF IMPRINT	Ø 42 mm
DIE BOX	EA-535-6
PACKING	



EA-655



EA-655	
SIZE OF IMPRINT	Ø 52 mm
DIE BOX	EA-655-6
PACKING	



★ **New** // **Premier** ★
LI-110 3 Simple Steps
 Flash ▶ Ink It ▶ Snap

Lite **NEW!** Int Pat.

Multicolor . Compact . Perfect to carry around

- 
1 Black
- 
2 White
- 
3 Blue
- 
4 Fuchsia
- 
5 Green
- 
6 Lavender
- 
7 Gold
- 
8 Silver



LI-75

**PREMIUM NOTICE
ENCLOSED**

LI-75	
SIZE OF IMPRINT	15 x 46 mm
DIE BOX	EA-75-6
PACKING	
COLOR	1~8

LI-110



LI-110	
SIZE OF IMPRINT	17 x 57 mm
DIE-BOX	EA-110-6
PACKING	
COLOR	1-8

LI-150

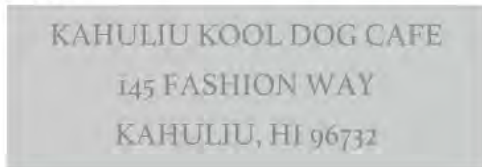

LI-150	
SIZE OF IMPRINT	22 x 64 mm
DIE-BOX	EA-150-6
PACKING	
COLOR	1-8

LI-190

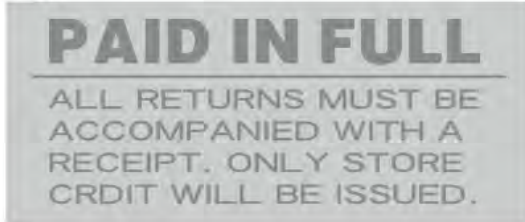

LI-190	
SIZE OF IMPRINT	30 x 70 mm
DIE-BOX	EA-190-6
PACKING	
COLOR	1-8

LI-245



LI-245	
SIZE OF IMPRINT	38 x 83 mm
DIE-BOX	EA-245-6
PACKING	
COLOR	1-8

LI-655



LI-655	
SIZE OF IMPRINT	∅ 52 mm
DIE-BOX	EA-655-6
PACKING	
COLOR	1-8



60 ml

Eminent Speed Ink

For Flash Stamp



PACKING · POLYBAGGED +

Color	Item No.				
	15 ml	60 ml	240 ml	950 ml	3,800 ml
	AV-□-2	AV-□-4	AV-□-5	AV-□-7	AV-□-9
Black	AV-61-2	AV-61-4	AV-61-5	AV-61-7	AV-61-9
Red	AV-62-2	AV-62-4	AV-62-5	AV-62-7	AV-62-9
Blue	AV-63-2	AV-63-4	AV-63-5	AV-63-7	AV-63-9
Violet	AV-64-2	AV-64-4	AV-64-5	AV-64-7	AV-64-9
Green	AV-65-2	AV-65-4	AV-65-5	AV-65-7	AV-65-9
Capacity					



15 ml



950 ml



240 ml



3,800 ml

Ink

Premier Line / Lite

82

Accessories

Flash Machine



FM-2000

FM-2000 Exposure area: 66 x 134 mm

Specifications:

- 9 Exposure setting.
- Compatible with FM1-□□□ template to produce multiple die-boxes at one time.
- EA-700 and EA-800 require 180° rotation for the 2nd flash to complete the exposure.



FM-2000A

FM-2000A Larger exposure area.

Specifications:

- 9 Exposure setting.
- Compatible with all Premier Line / Lite sizes
- Comes with an adapter to use FM1-□□□ template.
- FM2-□□□ template is an option for large volume production.
- When using FM2-□□□ template, OHP-2 transparency can be an option.

Template

The patented template enables easy alignment of the artwork, just simply drop the die-box into those cavities before flashing production.

FM1-□□□ for FM-2000



FM1-□□□
(except EA-700,
EA-750, EA-800)

FM1-750

FM1-700 / FM1-800

FM2-□□□ for FM-2000A

For large volume production.



Premier Inking Machine



Producing a Premier Pre-Inked Stamp



1 New easy refilling die box, transparency and artwork.



2 Place the artwork and transparency on the glass plate of the flash machine.



3 Place the template over the transparency.



4 Place the die box into the template.



5 Press the flash button.



6 Remove the die box from the template.



7 Fill the ink cavities with the suggested ink volume.

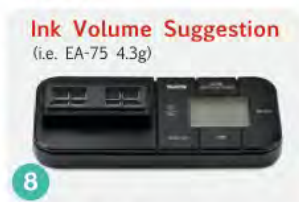

8 Use a gram scale for a perfect initial load.



9 Snap the die box into the mount.



10 Your Premier Stamp is ready to make imprint in 20 minutes.

Producing a Lite Pre-Inked Stamp



1 New easy refilling die box, transparency and artwork.



2 Place the artwork and transparency on the glass plate of the flash machine.



3 Place the template over the transparency.



4 Place the die box into the template.



5 Press the flash button.



6 Remove the die box from the template.



7 Fill the ink cavities with the suggested ink volume.

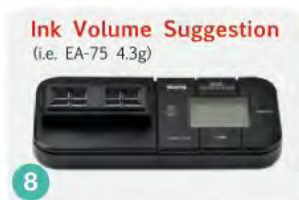

8 Use a gram scale for a perfect initial load.



9 Snap the die box into the mount.



10 Ready to make imprint in 20 minutes.

Gram Scale

This gram scale reads 0.01g increment, and can be switched between 6 different measurement: gram, ounce, troy ounce, carat, penny weight and grain.

- Net weight: 131 g
- Dimensions: 15 x 6.4 x 1.8 cm



<https://www.amazon.com/Tanita-1579-Digital-Pocket-Scale/dp/B005JZ13JG>

Refill Ink Instructions For Premier Line



1 To refill ink, please use Shiny Eminent Speed Ink to guarantee ultimate performance.



2 Remove handle from the stamp mount.



3 Add 3~5 drops of ink to each tunnel for best results.



4 Put stamp handle back to the mount.

Refill Ink Instructions For Lite



1 To refill ink, please use Shiny Eminent Speed Ink to guarantee ultimate performance.



2 Remove both display window and display label from the stamp mount.



3 Add 3~5 drops of ink to each cavity for best results.



4 Put display window back to the mount.

Eminent Speed Ink

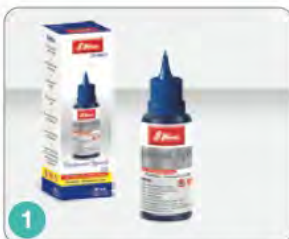

1 To refill ink, please use Shiny Eminent Speed Ink to guarantee ultimate performance.



2 Cut off the tip as shown.



3 Once the tip is cut off, use the cover from its original packaging after each use.



4 Snap the cover.

Eminent Line Eminent Kit



EK-□□□□ : Eminent Kit (Kit Form)

★(alternatively, pre-inked cartridge version is also available by request)

E-□□□□ : Eminent Line (Assembled Stamp)



1. Soft handle



2. Black

3. Blue

4. Yellow

5. Red



E-1313



EK-1313 / E-1313	
SIZE OF IMPRINT	13 x 13 mm
PACKING	
COLOR	2~5



E-2323



EK-2323 / E-2323	
SIZE OF IMPRINT	23 x 23 mm
PACKING	
COLOR	2~5



E-3012



EK-3012 / E-3012

SIZE OF IMPRINT 12 x 30 mm

PACKING

COLOR 2~5



E-3914



EK-3914 / E-3914

SIZE OF IMPRINT 14 x 39 mm

PACKING

COLOR 2~5



E-4217



EK-4217 / E-4217

SIZE OF IMPRINT 17 x 42 mm

PACKING

COLOR 2~5



E-4425

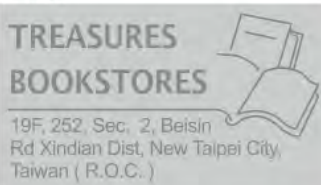

EK-4425 / E-4425

SIZE OF IMPRINT 25 x 44 mm

PACKING

COLOR 2~5



E-5020

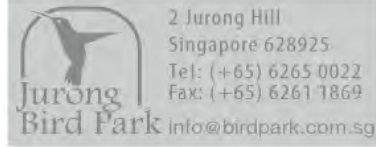

EK-5020 / E-5020	
SIZE OF IMPRINT	20 x 50 mm
PACKING	
COLOR	2-5



E-5717



EK-5717 / E-5717	
SIZE OF IMPRINT	17 x 57 mm
PACKING	
COLOR	2-5



E-6322



EK-6322 / E-6322	
SIZE OF IMPRINT	22 x 63 mm
PACKING	
COLOR	2-5



E-5232



EK-5232 / E-5232	
SIZE OF IMPRINT	32 x 52 mm
PACKING	
COLOR	1



E-6035

**EK-6035 / E-6035**

SIZE OF IMPRINT 35 x 60 mm

PACKING



COLOR

1



E-7030

**EK-7030 / E-7030**

SIZE OF IMPRINT 30 x 70 mm

PACKING



COLOR

1



E-7727

**EK-7727 / E-7727**

SIZE OF IMPRINT 27 x 77 mm

PACKING



COLOR

1



EK-7550

**EK-7550**

SIZE OF IMPRINT 50 x 75 mm

PACKING



COLOR

1

EK-9975



EK-9975	
SIZE OF IMPRINT	75 x 100 mm
PACKING	
COLOR	1

Special feature of EK-7550 / EK-9975

Remove cap cover and adjust the height of stamp mount accordingly if necessary.

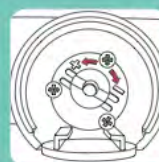

E-0033

EK-0033 / E-0033	
SIZE OF IMPRINT	Ø 33 mm
PACKING	
COLOR	1



E-0043

EK-0043 / E-0043	
SIZE OF IMPRINT	Ø 43 mm
PACKING	
COLOR	1



E-4933

EK-4933 / E-4933	
SIZE OF IMPRINT	33 x 49 mm
PACKING	
COLOR	1

Eminent Ink



PACKING · POLYBAGGED +

Color	Item No.	Capacity
	E-161-□	15 ml
	E-161-□-1K	1,000 ml
Black	E-161-9	
Red	E-161-2	
Blue	E-161-3	
Violet	E-161-6	
Green	E-161-5	



15ml

Please Note

The Eminent Ink is for Eminent Stamp, Premier Line, Lite, Essential EO Stamp, and Thumb Print Pad only.



Eminent Kit



1

Place dry cartridge.

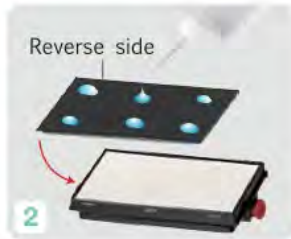

2

Glue processed flash die to cartridge. (Recommended)



3

Apply trim ring to stamp mount.



4

In order to refill ink, set the stamp on the two supports.



5

Fill the ink into the holes in the center.



6

Gently insert the ink tubes into the holes in the center to fill the ink.



7

Press the red side buttons to insert the stamp mount.



8

Ready to use.

Alternatively, the Eminent Kit pre-inked cartridge version is also available



1

Remove dummy cover from the stamp mount.



2

Glue processed flash die to cartridge.

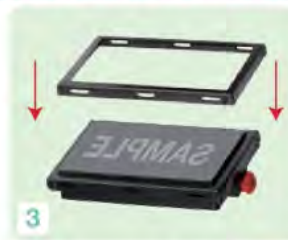

3

Apply trim ring to stamp mount.



4

Place the migration accelerator and close the bottom cover (with the migration accelerator in position) to speed up the ink penetration.

Remove the migration accelerator when the flashed die is inked.



Our priority is to make clients No. 1 in the market !
www.shinystamp.com



C-08



2017



© 2017 Shiny Stamp