



US UNIVERSAL SCALES WEIGHT EQUIP L.L.C

شركة الموازين الدولية (معدات الوزن)

خدمة معايرة - الاصلاح و الصيانة - حلول وزن - معدات ونظم وزن صناعية

حلول برمجية حسب الطلب - دعم وحلول



www.universalscales.com, info@universalscales.com

شركة الموازين الدولية

شركة الموازين الدولية هي واحدة من الشركات المعروفة والرائدة في مجال تصنيع وبيع الموازين و معدات الوزن ذات الجودة الفائقة . تأسست الشركة عام 1976م ، وقامت بنشر خدماتها في هذا المجال خلال 40 عاماً . وتخصصت شركة الموازين الدولية في المجال التصنيع

والبيع بالتجزئة لمعدات الوزن والمنتجات المختلفة الأخرى. كما نقوم أيضاً بتوفير خدمات الصيانة والاصلاح في المناطق التي تغطيها خدماتنا ، مثل الامارات العربية المتحدة ، والمملكة العربية السعودية وعمان، وباكستان. وتمتاز منتجات شركة الموازين الدولية بالدقة والمتانة، وهي موثوق بها وفوق كل ذلك متاحة بأسعار تناسب الجميع ، لهذا تمتاز بسمعة طيبة وسط الشركات العاملة في هذا المجال.

Our Mission

To deliver the best weighing solutions and services to our valued clients that will help them understand their goals while getting higher profits & targets.



Our Vision

To be a global rival in this industry renowned for developing the best in class weighing solutions and products through continuous research and innovation

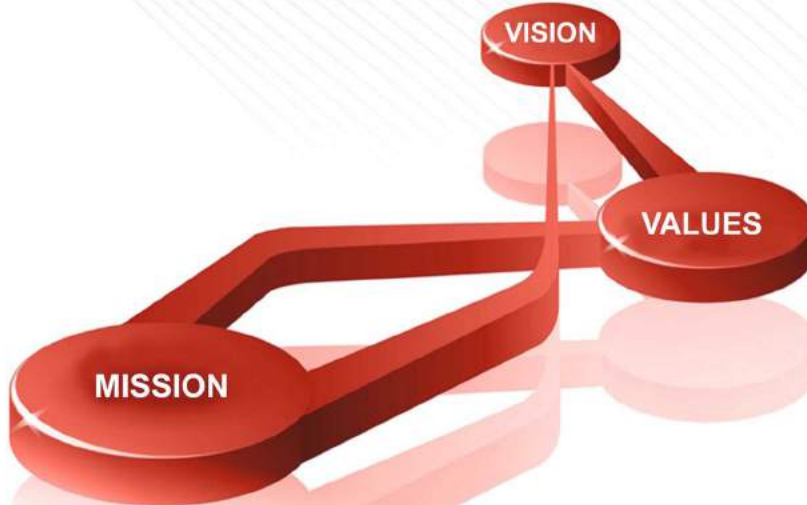

Universal Scales was established and has been providing its services in weighing scales industry since the year 1976. We have started our business with selling of mechanical scales. Later than, the Company became an exclusive representative Berkel International B.V.Holland which is recently recognized as Avery Berkel and Weigh Master-England.

After forty successful years, Universal Scales expanded its business and dealing in Electronics Scales in the year 1980. In starting, we have imported the complete product only from MSI and Rice Lake USA and after two years; we have only imported the essential components to manufacture and assemble the scales in our own manufacturing Plant. Universal Scale has started the fabricating of platform scales and weighbridges of different sizes in its own manufacturing unit. Universal Scales has developed its business and importing Electronic Scale's equipment and tools from some Asian and Eastern companies specifically Teroka and Yamato in Japan. Universal Scales is one of the top ranking company dealing especially in retail Scales, Barcode Label scales, Floor Scales, truck weighbridge as well as all other kinds of Electronic Scales.

We have Three major division under operation



RETAIL SOLUTION

حلول البيع بالتجزئة

SCALES & INDUSTRIAL WEIGHING EQUIPMENTS

موازين ومعدات الوزن الصناعية



SOFTERWARE DEVELOPMENT WEB DEVELOPMENT

تطوير المواقع



حائزة على اعتراف واعتماد



063
ISO-9001-2008



US UNIVERSAL SCALES
WEIGHT EQUIP L.L.C

موزعون معتمدون

FLINTEC

ACLAS

Cardinal
Cardinal Scale Manufacturing Co.

///AXIS

PRICER
SHAPING SMART RETAIL



TRUCK WEIGHBRIDGE

موازين الشاحنات



WEIGHBRIDGE

موازين



LOAD CELLS FOR SCALES

خلايات الموازين

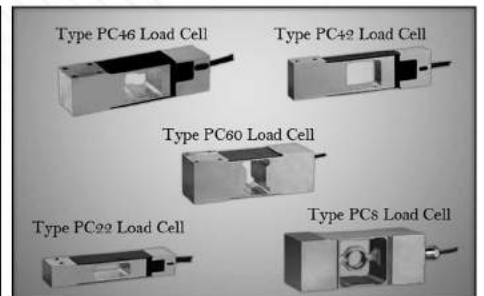
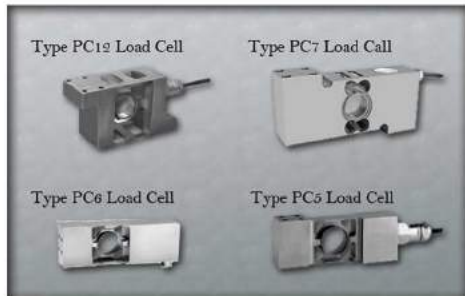

WEIGHT INDICATORS

مؤشرات الوزن



LOAD CELLS

خلايا تحميل

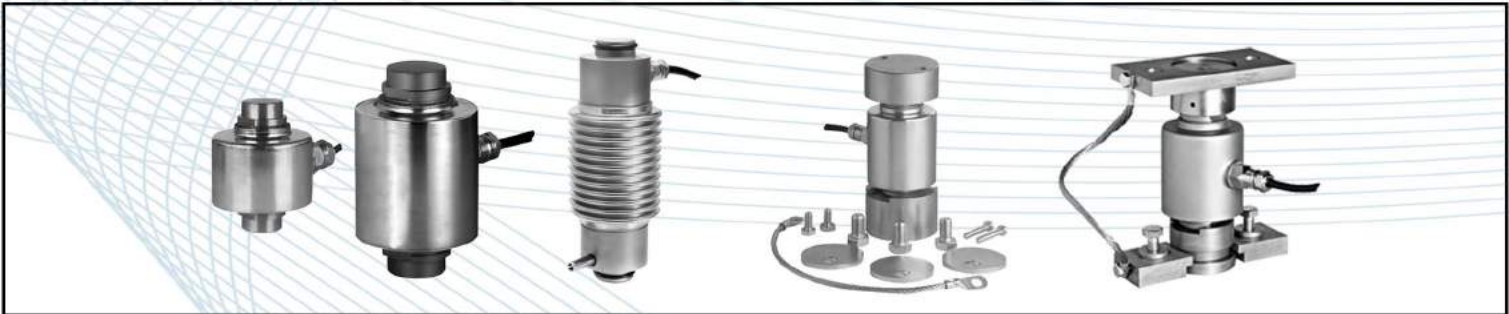

LOAD CELLS JUNCTION BOX

أطقم خلايا تحميل

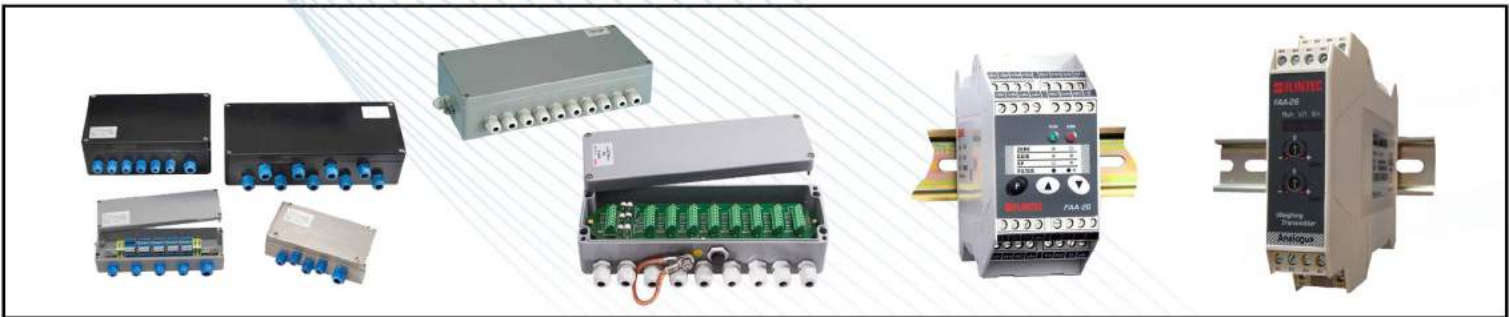

WEIGHT DISPLAYS

مؤشرات



///AXIS®

ANALYTICAL BALANCES

موازين تحليلية



GOLD/JEWELRY BALANCES

موازين مجوهرات



LABORATORY BALANCES

ميزان معمل



MOISTURE ANALYZERS DEIVCES

أجهزة تحليل الرطوبة



///AXIS



BARCODE LABEL SCALES

موازين الباركود أستيكر



CASH MACHINE/CASH REGISTERS

آلة تسجيل النقود



PRINTER PRODUCTS

منتجات طابعة



SERVICE CALLING SYSTEM/PAGING SERVICES SYSTEM

نظام النداء الآلي للخدمات



POS & ANTI THEFT DEVICES

نقاط البيع و جهاز للحماية من السرقة



OTHER PRODUCT

- ECR Series & Touch POS
- Fiscal Printer

WEIGHT INDICATORS

مؤشرات الوزن



LOAD CELLS

خلايا تحميل



REMOTE DISPLAYS

موازين حاسبة



PLATFORM & FLOOR SCALES

موازين أرضية



PROCESS WEIGHING

Process Industries

Around one third of UAE's production is weighed using Scales Universal Process Weighing Systems, with thousands of high capacity load cells installed successfully on cement silos as well as those used in mixing & batching plants and feeding equipment. Food, pharmaceutical chemical and oil industries are key sectors. Due to our expertise in load cells for harsh environments, together with standard all stainless steel construction of both load cell and mounting assembly, customers in the metals industries find our high temperature load cells invaluable.

Main industries served:

- Cement
- Concrete batching
- Food and drink
- Pharmaceutical
- Chemical
- Minerals
- Biomass and wood pellets
- Paint
- Oil and Lubricants
- Plastics
- Metals
- Adhesives
- Inks and coatings
- Agriculture and farming



Process Industries - more



Machine Builders / OEM

Scales Universal process weighing systems find many applications in the manufacture of specialised machinery that incorporates static or dynamic weighing as part of the process.

This includes materials handling equipment such as:

- Weigh feeders
- Belt weighers
- Big bag (FIBC) filling/emptying equipment
- Form-fill-seal machinery
- Check-weighers
- Filling machines
- Bagging Machines.
- Batching Systems.
- Multihead weighers and rotopackers
- And others...

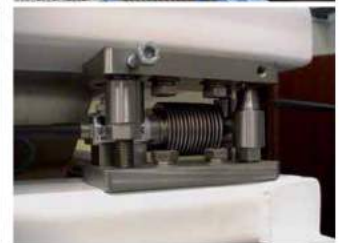

Weighbridges (Truck Scales), Axle Weighers and Weigh in Motion (WIM) Systems

Customers nation wide appreciate the excellent performance, rugged reliability and quality of our weighbridge (truck scale) load cells, which incorporate lightning surge arrestors and a durable rodent resistant polyurethane cable as standard.

We offer:

- Analogue load cells approved to OIML C4 and NTEP Class III L up to 60 tonnes
- Digital load cells with open protocol, approved to OIML C4 up to 60 tonnes
- Special version load cells for high accuracy WIM and axle weighing systems



Filling Machine





Step 1
Vehicle is Weighed

Step 3
Tickets is printed

Step 2
CPT Weighbridge records transaction

WEIGHBRIDGE SOFTWARE FEATURES

- Multiple Weighbridges/indicators
- Single Transactions
- Batch Processing
- In and Out Directions
- Multiple Weighments
- Loaded/Unloaded Weighments
- Multiple Modes: Sales/Purchase
- Custom Tickets
- Real time weight display
- Liquid Measurement display
- Gravity Control
- Smart sensor for all indicator types
- Real time data monitoring
- 10 Global Flexi/Custom Fields
- 10 Additional Indicator based Flexi/Custom Fields
- Complete Tare Information
- Service Information
- Payment Information
- Camera Support
- CCTV Settings
- Customers List
- Customer Pricing Control
- Suppliers List
- Transporters List
- Materials List
- Raw Materials Support
- Stock Control
- Specific Gravity Control
- Vehicles List
- Transactions Listings
- Batch Transaction Listings
- Weighment Search and filter options
- Tare reports
- Date wise reporting
- Shift wise reporting
- Weighment ledger
- Product/Material Wise reporting
- Custom reports
- Send reports to fax or email client
- Easy to add new reports
- Industry standard Crystal Reports support
- Purchase Requisitions
- Invoices
- Create invoice from weighments
- Activity Log
- System Settings
- General Settings
- Flexi/Custom fields settings
- Inventory settings
- Pricing Settings
- Smart Card Settings
- Gate Control
- Weighbridge Control
- Network Database
- Cloud Database
- Built in maintenance features
- Network Streaming
- CCTV Monitoring
- Camera – Motion detection
- Camera – Number plate detection
- Save/Print tickets
- Smart Cards Support
- Manual smart card support
- Easy data entry
- Shortcut Keys
- Easy Accessibility
- Scale Configuration
- Inside Vehicles Count
- Resume Weighment Option
- Employees List
- Employee Shifts
- Operators Access Control
- User privileges
- Operator log
- Drivers List
- Area List

SOFTWARE AND SERVICES

Retail pos, hospitality, restaurant pos & meat shop pos

POINT OF SALE



CPT WEIGHBRIDGE



CHEQUE WRITING SOFTWARE

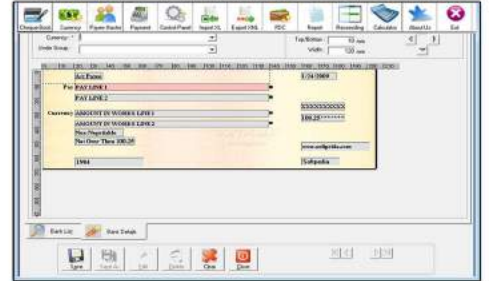

INVENTORY MANAGEMENT SYSTEM



WEIGHING SCALE



SCALE LOGGER



US AIR



WE DEAL IN ALL IT SOLUTIONS

WEB HOSTING



WEB DEVELOPMENT & DESIGNING



MOBILE APPS



Software Development

Custom Application Development

CUSTOM SOFTWARE DEVELOPMENT

<https://www.classpointtechnology.com/>

OTHER PRODUCT OF CARDINAL

- Hanging Scales
- Live-Stock-Scales
- Load Cell Kits
- Mobile Apps
- Over head Track Scales
- TankHopper Scales
- Truck Scales
- Weight Indicator



- موازين معلقة
- موازين للمواشي
- أطقم خلايا تحميل
- تطبيقات جوال
- موازين العاية الطول
- موازين خزانات للسوائل
- موازين شاحنات
- مؤشرات الوزن

PRICER 

SHAPING SMART RETAIL

SmartTAG HD



PRICER 

SHAPING SMART RETAIL

UNIVERSAL SCALES WEIGHT EQUIP L.L.C



OUR LOCATIONS

Riyadh - Saudi Arabia

Optical Arrow Trading EST.
P.O Box.57409.
Riyadh 11584. Kingdom Of Saudi Arabia.
info@universalscales.com

Jeddah - Saudi Arabia

Jeddah, Khalid Bin Walid Street.
Walid Center.1st Floor.
Office No.107 Business Soft
info@universalscales.com

Muscat - Oman

+968-92124936
info@universalscales.com

Dubai United Arab Emirates

MaM Building No 2, Suit #9, Souk
Al Kabir, Khalid bin waleed road
Bur Dubai- UAE

+971 4 351 5808
info@universalscales.com

Sharjah

Behind Toyota Showroom,
Al Wahda Street,
Sharjah, UAE P.O. Box: 23215

00-971-6-5322313
info@universalscales.com

Ajman

New Industrial Area Ajman, Behind Fruits
And Vegetable Market, Shade Number: 113,
Beside Ahlan Super Market, Ajman

+971 06 748 4466
info@universalscales.com

Karachi - Pakistan

915,9th Floor, Uni Plaza,
I.I. Chandigarh Road
Karachi, Pakistan.

+92-21-37588562
info@universalscales.com

Lahore - Pakistan

A-31 katcha ferozpur Road
Mozung Chowrangi,Lahore

+92-42-37500277, 042-37500278
info@universalscales.com

Nowshera - Pakistan

Ground Floor Hakim Building-
Hakimabad Nowshera,
KPK Pakistan

+92-923-610388 , +92-923-614006
info@universalscales.com

WEBSITE

www.universalscales.com

E-MAIL ADDRESS

info@universalscales.com

ACCREDITATION &
CERTIFICATION



063

ISO-9001-2008